

A Ham's Guide to RFI, Ferrites, Baluns, and Audio Interfacing

Revision 5a 5 Jun 2010

by Jim Brown K9YC

Audio Systems Group, Inc.

<http://audiosystemsgroup.com>

The basis of this tutorial is a combination of my engineering education, 55 years in ham radio, my work as vice-chair of the AES Standards Committee working group on EMC, and extensive research on RFI in the pro audio world where I've made my living. That work is documented in technical papers and tutorials that can be downloaded from the publications section of my website.

Chapter 1 – Some Fundamentals

To solve interference problems, we must understand them. So we'll begin by describing the ways that RF interference is coupled into equipment and detected. There are several principal mechanisms at work. You should study this tutorial thoroughly to understand how these things work.

Detection at Semiconductor Junctions Every semiconductor junction, whether part of a diode, transistor, or integrated circuit, is quite nonlinear, especially in the voltage region where it is beginning to conduct. In analog circuits, we prevent this non-linearity from causing distortion by properly biasing the circuitry, by using lots of negative feedback, and by preventing the signal from being large enough to cross into the cutoff region.

Thanks to this non-linearity, every semiconductor junction functions as a *square law detector*, detecting any RF signal it sees. A good designer prevents detection by shielding the equipment and its wiring, by filtering input and output wiring, and even by bypassing the junction by a capacitor.

Since virtually all detection that causes RFI follows square law, the strength of the signal detected by audio equipment, telephones, and other equipment will increase (or decrease) as the square of any increase (or decrease) in RF level at the detector. ***In other words, the strength of the detected RF changes by twice the number of dB that the RF signal changes.*** This means that if we manage to reduce the interfering RF signal by 6 dB, the detected audio will drop by 12 dB. This is a very useful thing – it means that we may not need "an elephant gun" to solve many interference problems.

Antenna Action The most fundamental cause of radio interference to other systems is the fact that the wiring for those systems, both inside and outside the box, are antennas. We may call them "patch cables" or "speaker cables" or "video cables" or "Ethernet cables," or printed circuit traces, but Mother Nature knows that they are antennas! And Mother Nature always wins the argument.

When we transmit, some of the RF from our transmitter is picked up by those unintentional antennas, and RF current flows on them. What happens to that current determines whether there will be interference, and how severe it will be. We know that antennas work in both directions – that is, they follow the principle of *reciprocity* – so when RF trash from inside the box flows on those antennas, it is radiated as noise and we hear it on the ham bands.

Fig 1 shows a simple antenna we've all used, probably with our first radio receiver. We connected a random wire to our receiver, and the antenna current flowed through the receiver to a "ground" that might have been a driven rod, but was more likely the safety ground of the AC power line (the third pin on the AC socket, known in North America as the "green wire"). Even if the radio was double insulated so that it didn't require the green wire connection, RF current still flowed through the stray capacitance of the power transformer to the power line and made the radio work.

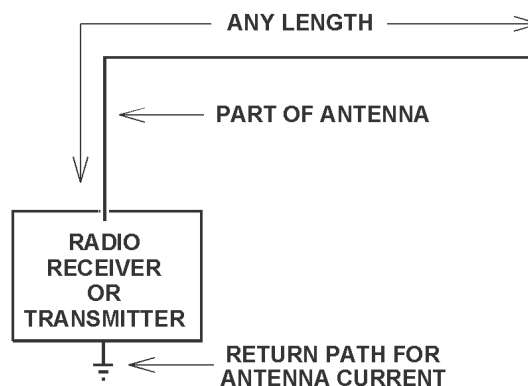

Fig 1 – A simple random wire antenna

RF picked up on the antennas we call loudspeaker wiring, video cables, the coax from the cable TV system or a rooftop TV antenna, flows through equipment to get to the AC power system safety ground. Hams understand that some antennas are more effective than others. An antenna that is

close to resonance will work better than one that is not. Long antennas tend to pick up more RF than short ones. Think about these fundamental principles when trying to diagnose which cables are bringing your RF into a given system (or radiating their trash into your receiving antenna).

A path to "ground" or the power system is not always needed to produce antenna action. The whip antenna on our VHF and UHF handheld radios uses the radio, capacity-coupled to our hand that holds it, as a counterpoise (that is, to provide "the other half of the antenna"). All that is required for this to work is that the size of the counterpoise must be a significant fraction of a quarter wave (or larger) so that it can "sink" the antenna current.

Common Mode and Differential Mode Signals A *differential mode* signal is one that exists between the conductors of a cable. At any given point along the cable, current flowing on one conductor is precisely balanced by current flowing in the other direction on the other conductor. The intentional signals carried by cables are differential mode signals – the audio or video signal in a home audio system, Ethernet signals on CAT5/6 cable, and the RF signal carried by the feedline connecting our antennas to our transceivers.

A *common mode* signal is one that places equal voltage on all conductors – that is, the voltage between the two ends of the cable are different, but there is no voltage between the conductors. Antenna action produces a *common mode voltage* and current along a cable. The antenna current induced on audio and video wiring is a *common mode* signal. That is, with "ideal" cable, there is no differential voltage between the signal conductors as a result of this antenna action. If the cable is shielded, nearly all of this current flows on the shield (and skin effect causes it to flow on the outside of the shield). If the shield is ideal (that is, if the current is distributed with perfect uniformity around it), the field inside the shield will be zero, and thus none of this antenna current will flow inside the cable. Conversely, when a cable shield is carrying differential mode current, as in the case of coax, skin effect will cause that differential mode current to flow on the inside of the shield.

The real world is not ideal, so most interfering signals will simultaneously exist in both common mode and differential mode, but in most real world conditions, one or the other mode dominates.

Several cable defects (essentially manufacturing tolerances) certainly can and do convert this "common mode" antenna current to a differential signal (that is, a voltage between the signal conductors), but that is rarely the most powerful coupling mechanism. One common defect that affects both balanced and unbalanced cables is imperfect construction of cable shields. In even the best "real world" balanced twisted pair cables, there are imbalances in the capacitance between "red" and "black" conductors to the shield on the order of 5%. [B. Whitlock, JAES, June 1995] In balanced paired cables that use "foil/drain" shields, there is even more imbalance in the inductive coupling between each conductor and the shield. Noise (or RFI) coupled by this mechanism is called "shield-current-induced noise," or SCIN. [N. Muncy, JAES, June 1995] All three of these mechanisms convert shield current to a differential signal at system input and output terminals.

If the cable is an unshielded pair (loudspeaker cable, for example), RF will be induced approximately equally on both conductors (but, depending what the input circuit of the equipment looks like at RF, current flow into the equipment may not be equal on both conductors). This can also produce a differential voltage at the input (or output) terminals.

Output Wiring is Important Too! It is well known, for example, that RF interference is often coupled into the output stage of audio equipment – for example, the power amplifiers that feed loudspeakers or headphones. There is always feedback around that output stage, so RF present at the output will follow the feedback network to the input of a gain stage, where it will be detected and amplified. This problem is made much worse when parallel wire cable (zip cord) is used to feed the loudspeakers or headphones, and can usually be solved simply by replacing the zip cord with a twisted pair of POC (plain ordinary copper). [Pseudo-scientific advertising hype for exotic cables notwithstanding, it was shown nearly 30 years ago that #12 copper twisted pair (or #10 for very long runs) is a nearly ideal loudspeaker cable.] [R. A. Greiner, "Amplifier Loudspeaker Interfacing," JAES Vol 28 Nr 5, May 1980] As we will discuss later, the twisting of a pair greatly reduces the level of RF that the wiring couples to circuitry.

Power Supply and Control Wiring can also act as antennas. When I bought the house I owned in

Chicago, I upgraded the electrical wiring and put all of it in steel conduit (EMT). This shielded the wiring, so that only the short power cords between equipment and the wall outlets could act as antennas. The house I recently bought in California is wired with no conduit, using unshielded parallel conductors. Thanks to its length, and the fact that it is not shielded, this wiring acts as an effective receiving antenna for the RF I am transmitting, and an effective transmitting antenna for the RF trash generated by computer equipment, power supplies for low voltage lighting fixtures, and even battery chargers.

Current Returns to its Source Current flows in a complete circuit that includes the source of the current. The circuit will couple noise inductively, and also by antenna action. The cause of many RFI and noise problems, as well as the solution to them, lies in identifying and controlling these circuits. *Always ask, "Where does the noise (or RFI) current flow?"*

Loop Area One of the most fundamental laws of electrical circuits is that the current that is magnetically induced between two circuits is proportional to the loop area of each circuit. Making the loop area small also minimizes the extent to which the wiring can act as an antenna. When we use a closely coupled pair of conductors to form a transmission line, we are reducing the loop area, which reduces the total current induced in the loop by an interfering signal, and the total magnetic field produced by current in that loop. The transmission line, of course, has other useful properties. More on this later on.

The equipment designer can also use multilayer printed circuit techniques to place a "ground" (reference) plane next to all signal wiring, turning each circuit trace into an unbalanced transmission line, where the return current is carried on the reference plane under wiring. A single reference plane makes a very large reduction in the ability of that circuit trace to receive interference; sandwiching it between two such planes virtually eliminates it. These techniques, called microstrip (one plane), or stripline (the sandwich), are widely used by better designers. They reject noise coupling both inside and outside the equipment by drastically reducing the loop area of the current path (and have the additional benefit of making high speed data circuits behave better because they are transmission lines).

Loaded Words That Cause Misunderstandings One of the most overused and misunderstood words in electronics is "ground" (or "earth" in British English). There are several important and common uses of the words. One meaning is an actual connection to mother earth. Some common earth connections include the steel structure of a building, a buried conductive water pipe, a concrete encased grounding electrode (called a Ufer, after its inventor, Herbert Ufer), and, of course, one or more conductive rods driven into the earth. [Concrete mixes vary widely in their conductivity – most we are likely to encounter are highly conductive, but some are effective insulators.] The primary function of this earth connection is lightning protection.

A second common use of the word "ground" (or "earth" in British English) is a third conductor that is part of the power system wiring that should never carry current (except in the case of a fault) but connects the conductive enclosures of equipment to a common point within the power system. This "green wire" or third pin in the outlet in North American power systems, is called the "equipment ground" (or "protective earth" in British English). The green wire is required to be connected to all exposed conductive parts of electrical equipment "that might be energized" in the event of equipment failure. The purpose of this connection is to provide a sufficiently robust current path that a fuse will blow or circuit breaker will trip in the event of equipment or wiring failure that causes the chassis to be "hot," thus protecting people from electrical shock and preventing fires.

A third common use of the word "ground" (or "earth" in British English) is to describe "circuit common" or "circuit reference" within equipment. Circuit common should nearly always be connected to the power supply reference, and to the shielding enclosure of the equipment. If the source of noise is within equipment, circuit common is reference for the noise voltage (and current), and it is the point to which that noise current wants to return.

A fourth common use of the word "ground" is as the "return" for an unbalanced antenna like a vertical or long wire. In this application, the antenna needs some conductor to be a low impedance "sink" for the antenna current. The radials for an elevated or ground-mounted vertical antenna

serve this function. There is an excellent discussion of this in <http://w2du.com/Chapter05.pdf>

Ground Wiring Some hams like to think of the earth as if it were somehow a "sink" into which all noise can be poured, never to bother us again. Indeed, you'll find lots of bad advice to solve RFI problems with "a better ground." In fact, nothing could be further from the truth. ***An earth connection is rarely part of a solution to RF or noise problems.*** Rather, we need a better understanding of the four common meanings of "ground," that "ground" is not a single point, and that connections between them change current paths. [There are exceptions to every "rule," and this no exception. See "Shunting Common Mode RF to Earth" later in this tutorial.]

Consider a noise filter hanging between some piece of noisy equipment and the power line, with capacitors from the "hot" and "neutral" to "ground." What is that "ground?" It is circuit common and the shielding enclosure of the equipment, the green wire in the power cord, which is connected to the equipment ground in the power system, which goes to the breaker panel, which is in turn bonded to neutral and a real earth connection at the service entrance to our building (and, if we've done it right, there should be a bond between the power system ground and any grounds we've added for our radio equipment). In most systems, the green wire follows a rather long path – typically a quarter wave on 80 meters, and perhaps even on 160 meters. That current path is an antenna, and any RF current flowing on that conductor will radiate! In fact, the connection to earth may increase current flow. Like any other radiated RF signal, our receiving antennas will hear it. All of those "ground" connections must be present to have a safe installation, ***but it is the combination of the high series impedance of the filter's choke and the connection between the filter's "ground" and the shielding enclosure of the equipment (and it must be very short) that suppresses the noise. The earth connection provides lightning safety.***

This basic scientific fact has major implications in the design of filters intended to prevent noise coupling from noisy equipment to our ham stations. If we add a filter to wiring that enters or leaves a piece of noisy equipment, it is the shielding enclosure for that equipment to which any "ground" of our filter should return (and, of course, circuit common should also be connected to that shielding enclosure). All connections between the filter and the noisy equipment should be as short as possible (what my old EE professors liked to call "zero length" to emphasize the importance of making them short). Why? First, to minimize the loop area, and thus the inductance. Second, to minimize antenna action. More about this when we discuss specific filter designs.

Insufficient Input and Output Filtering As hams, we know that equipment needs good input and output filtering to prevent RF from coming in on input and output wiring. Beginning in the 1950's, hams operating the HF bands were deluged with TVI complaints because television manufacturers failed to include high pass filters in their sets. Likewise, audio equipment needs good low pass filtering to reject our signals. Many myopic designers of "high futility" audio gear (and even some professional gear) don't include low pass filters because they don't want to degrade the phase response of the audio path. While good phase response is certainly important, so is RF rejection. Good engineering can satisfy both needs without compromise. Ever since those early days, hams have always assumed that a good low pass filter will kill RFI in audio systems, and a good high pass filter will kill interference to FM and TV. Unfortunately, while good filtering is important, other mechanisms are far more important in most real world situations.

Shield Resistance adds hum and buzz to unbalanced wiring (audio, video, and data (RS232)). The "green wire" at every AC outlet is at a different potential, thanks to leakage current of equipment plugged into that outlet, as well as other leakage current flowing on the green wires. When that equipment is interconnected with unbalanced wiring, the difference in potential (60 Hz and its harmonics, plus noise) causes current flow on the shield, and the IR drop is added to the signal. A "beefy" shield (big copper) minimizes R – that's why the best video cables use heavy copper shields! Audio transformers eliminate the hum/buzz by breaking the current path at DC and audio frequencies, but most hum and buzz in your ham station can be solved without a transformer – simply power all interconnected gear from the same outlet, bond equipment all chassis' together, and use coax with beefy copper shields for audio. ***An unshielded transformer can make matters worse, coupling noise from a power transformer into its unshielded windings.*** See Chapter 8 for more.

The Pin 1 Problem: The most common way that hum, buzz, and RF interference enters equipment is via a design defect first widely understood by the pro audio community thanks to the work of Neil Muncy, (ex-W3WJE). He named it "the pin 1 problem," because it is a mis-wiring of the shield of audio cables – pin 1 in the XL connector commonly used for pro audio, but it is just as much a problem in unbalanced interfaces of all types, as shown in Fig 2.

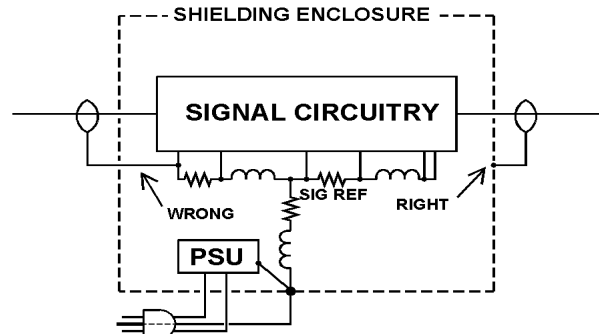

Fig 2 – The Pin 1 Problem

The proper connection for a cable shield to equipment is the shielding enclosure (chassis), but products with a "pin 1 problem" connect the shield to the circuit board instead. Nearly all consumer equipment, including even the most expensive "high fidelity" gear, is built with pin 1 problems. Virtually all computer sound cards have pin 1 problems. So do most RS-232 interfaces and nearly all ham equipment – indeed, *almost all RFI problems we describe as "RF in the shack" have pin 1 problems as their root cause!*

Fig 2 illustrates both right and wrong connection of the shield. The trouble-free connection on the right goes straight to the shielding enclosure, so shield current flows harmlessly out the safety ground on the power cord. Any noise (or RF) on the cable shield stays "outside the box."

The connection on the left, however, is a pin 1 problem. Current flowing on the shield bypasses the shielding enclosure and is forced onto the "ground bus" – that is, "signal common." To get to the power system ground, noise current must follow that "ground bus" around the circuit board – what Henry Ott calls "the invisible schematic hiding behind the ground symbol." The wires and circuit traces that make up that invisible schematic have resistance and inductance by virtue of their length, and the IZ voltage drops across those R's and L's are coupled into each "gain stage" that connects to the ground bus! Once that happens, every semiconductor junction that "sees" the RF will detect it, and succeeding gain stages will amplify the detected RF.

What if there is no "shielding enclosure?" Fig 3a and 3b shows how to avoid pin 1 problems with unshielded or partially shield equipment. (Of course, unshielded equipment has other potential problems, which we'll talk about later.)

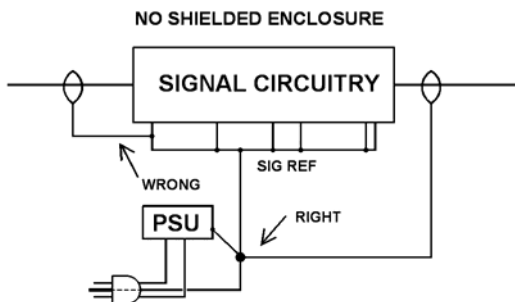

Fig 3a – 120VAC power

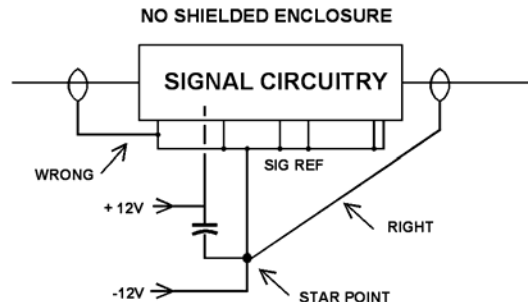

Fig 3b – 12VDC power

Why is equipment built with pin 1 problems? Two reasons. First, "fuzzy thinking" on the part of engineers, who have lost track of where noise current flows. Second, the construction techniques used in modern equipment, and the connectors built to support those techniques, make it more likely that pin 1 problems will happen. In "the old days," we mounted an RCA connector or phone jack by drilling a hole and screwing it down to the chassis. Today, those connectors come with solder tabs for mounting directly to a printed circuit board, which is then built, tested, and fitted into an enclosure. Screwing those connectors down to the enclosure increases cost significantly! And **FIXING** pin 1 problems in equipment having this kind of construction can be quite difficult.

RFI and Pin 1 Problems There are three ways to cure RFI coupled by pin 1 problems. The first two

methods are obvious – modify the equipment to eliminate the pin 1 problem, or rewire the connections so that the shield goes to the proper connection point, as shown in Figs 2, 3a, and 3b. Unfortunately, the way that most equipment is built usually makes both of these methods difficult or impossible to implement.

The third method for curing RFI coupled by pin 1 problems is to eliminate or reduce the current. This is usually the best (the most practical, effective, and cost-effective). This is what we are doing when we use a ferrite choke on the wiring connected to a pin 1 problem, lift the shield at the receiving end of a balanced audio cable, or bond all our equipment together with short fat wires! We'll study ferrites in Chapter 2, and bonding in Chapter 8.

Shielding The wiring inside equipment can also act as an antenna if the designer allows it to do so. There are several ways to prevent this. The obvious one is to shield the equipment and bond (that is, make a solid electrical connection) that equipment shield to all cable shields entering that equipment. *Note that while we call circuit common "ground," no connection to earth (or even circuit common) is needed for shielding to be effective. (I have yet to see an aircraft trailing a ground wire, but the extensive instrumentation needed to operate and control it work just fine.)*

Twisted-Pair Cable is the single most important tool we can use to reduce RF pickup on an interconnecting cable. *In many circuits, twisting is far more important in rejecting noise and RF than a cable shield.* Since this statement may seem counterintuitive, let's examine why it is true.

A cable shield prevents electric field (capacitive) coupling, but it has little effect on magnetic fields (that is, inductive coupling). This is true at low frequencies because cable shields are not made of magnetic material. It is true at high frequencies because of imperfections in the shield that decrease the uniformity of current flow on the shield.

A transmission line does reject magnetic fields, but it does this by virtue of the mutual coupling between the conductors that causes the current and voltage induced in them by an external field to be equal and opposite, so they cancel at the input circuit to which the cable is connected. The degree of this equality depends on the coupling coefficient k , which is typically on the order of 0.7 for a closely spaced pair. An ideal coaxial cable, however, has a coupling coefficient of 1 above the cutoff frequency of the shield (see below). So, the shield of a coaxial cable is not a magnetic shield, it is an electric shield. Magnetic noise rejection is the result of mutual coupling between the center conductor and the shield, not because of shielding.

Another important fact explains why coaxial cables don't reject magnetically coupled low frequency hum and buzz. Cables don't exhibit mutual coupling at frequencies where the resistance of the conductor is greater than its inductive reactance. The low frequency at which this transition occurs is called the **shield cutoff frequency**. For most cables, this is between about 1 kHz (coax with a "beefy" double copper braid shield") and 20 kHz (coax with a foil/drain shield).

Twisting works to reject noise from the magnetic field because it causes the voltage induced in the two conductors to be more nearly equal. It also reduces electric field coupling in balanced circuits. In general, the "tighter" the twist, the more equal the induced voltage will be to the highest frequency. That's because any interfering field will vary with position based on the wavelength of the field. To understand this, consider any interfering source and a cable running past it. If the cable is not twisted, one conductor will be closer to the source, so more noise will be coupled to it than the other conductor. If the conductors are twisted, one conductor will be closer at one point along the cable, but one half twist further along the cable, the other conductor will be closer. The difference in spacing between the conductors may not sound like it should cause much difference in level, but if we need 100 dB of cancellation, the two voltages must be equal within .0001%, a very small margin of error.

Twisting is such a powerful mechanism for reducing noise coupling that telephone circuits have always used unshielded twisted pair. Likewise, very high speed Ethernet circuits are carried on tightly twisted pairs manufactured to close tolerances. To further reduce crosstalk from one pair to another, each pair in the cable is twisted at a slightly different rate. The author has demonstrated that sensitive microphone circuits connected with unshielded CAT6 cables are actually less susceptible to noise pickup than shielded balanced pairs, both at audio frequencies and at VHF/UHF!

This is true because the degradation in rejection due to imperfections in the cable tend to be greater than the relatively small benefit of the electric shield!

CAT5/6 cables carrying Ethernet data do radiate RF trash, but most of that radiation is common mode – that is, longitudinally along the cable – because the line drivers on either (or both) ends of the cable have poor common mode isolation. But this is a defect in those line drivers, not in the cable! We'll address RFI filtering of Ethernet cables later on.

RFI and Poorly Shielded Equipment There are few practical RFI fixes for poorly shielded equipment. The most obvious is to shield it, but this is usually either expensive or impractical if it wasn't built with good shielding. We could, for example, wrap it in aluminum foil, but to make that shielding effective, 1) we must bond the shields of all wiring that enters and leaves the equipment to that foil shield; and 2) any openings in the shield must be small as a fraction of the wavelength of the interfering signal; [It is quite difficult to watch a TV set, or adjust the controls of a stereo system, that is surrounded by aluminum foil!]; 3) Modify the defective product by adding filters (ferrite beads, bypass capacitors) to the junctions that are detecting the RF [you may have time for a science project like this, but I don't]; 4) use the **bucket treatment**.

The Bucket Treatment: Find a bucket large enough to hold the defective equipment, and fill the bucket with water. Put the equipment in twice. Take it out once.

Summary RF is coupled into equipment on wiring that acts as receiving antennas – loudspeaker wiring, telephone wiring, audio interconnect wiring, antenna wiring, even wiring inside equipment that is poorly shielded. The pin 1 problem is a widespread design defect in computer gear, audio and video equipment, and even ham gear, and is a major cause of RFI. Imperfect construction of cables also converts RF to a differential mode signal. Once "inside the box," RF is detected by semiconductor junctions, and added to the signal where it is heard as interference. Most antenna action outside the box can be suppressed by suitable ferrite chokes that block the current.

Chapter 2 – Ferrites

Ferrites can be a very effective tool for eliminating RF interference between systems. To use them effectively, we must understand them. Ferrites are ceramics consisting of various metal oxides formulated to have very high permeability. Iron, manganese, manganese zinc (MnZn), and nickel zinc (NiZn) are the most commonly used oxides. When a ferrite surrounds a conductor, the high permeability of the material provides a much easier path for magnetic flux set up by current flow in the conductor than if the wire were surrounded only by air. The short length of wire passing through the ferrite will thus see its self inductance "magnified" by the relative permeability of the ferrite. The ferrites used for suppression are **soft** ferrites – that is, they are not permanent magnets.



Fig 4 – A toroidal ferrite choke



Fig 5 – Ferrites are made in many forms

Permeability is the characteristic of a material that quantifies the ease with which it supports a magnetic field. **Relative permeability** is the ratio of the permeability of the material to the permeability of free space. The relative permeability of non-magnetic materials like air, copper, and aluminum is 1, while magnetic materials have a permeability much greater than 1. Typical values (measured at power frequencies) for stainless steel, steel and mumetal are on the order of 500, 1,000 and 20,000 respectively. Various ferrites have values from the low tens to several thousand.

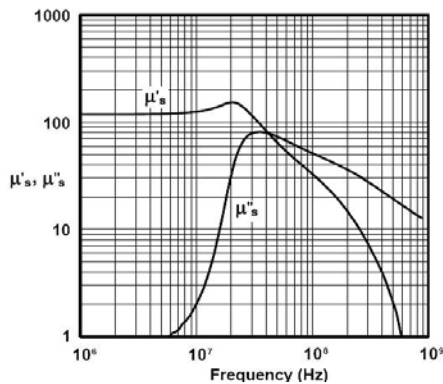

Fig 6 – Atypical ferrite material (Fair-Rite #61)

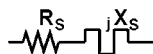

Fig 7a – Data sheet impedance

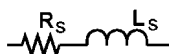

Fig 7b – Over-simplified equivalent circuit of a ferrite choke

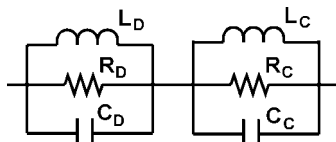

Fig 7c – A better equivalent circuit of a ferrite choke

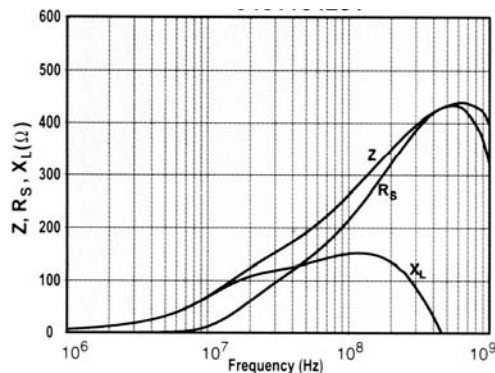

Fig 8 – A UHF material (Fair-Rite #61)

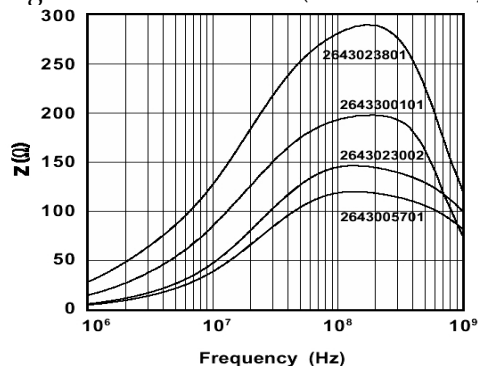

Fig 9 – Small cores of different lengths

Fig 6 shows complex permeability μ'_s and μ''_s for a ferrite material optimized for suppression at UHF. [For the engineers among us, $\mu = \mu'_s + j\mu''_s$. Thus μ'_s is the component of permeability defining ordinary inductance, and μ''_s describes the loss component.]

Product data sheets characterize ferrite chokes by graphing their series equivalent impedance, and chokes are usually analyzed as if their equivalent circuit had only a series resistance and inductance, as shown in Fig 7a and 7b. The actual equivalent circuit is closer to Fig 7c. We'll learn more about it as we go along.

Fig 8 is the manufacturer's data for a cylindrical bead of 5 mm o.d. and 23 mm long, defined in terms of the series R and X_L . Interestingly, X_L goes off the graph above resonance, but it isn't zero. If you have the equipment to measure it accurately, you will see negative reactance contributed by the capacitors in Fig 7c.

Below resonance, the impedance of a wire passing through a ferrite cylinder is proportional to the length of the cylinder. Fig 9 shows the impedance of a family of beads that differ primarily in their length. There are also small differences in their cross section, which is why the resonant frequency shifts slightly.

Manufacturers vary the chemical composition (the *mix*) and the dimensions of ferrites to achieve the desired electrical performance characteristics. Fig 8 is data for a sleeve made of a *mix* (#61) useful in suppressing RFI above 200 MHz. The #43 *mix* used for the beads of Fig 9 is optimized for suppression at VHF (30-300 MHz).

Like all inductors, the impedance of a ferrite choke below resonance is approximately proportional to the square of the number of turns passing through the core. Fig 10 is measured data for multi-turn chokes wound around the toroid of Fig 4 (2.4" o.d x 1.4" i.d. x 0.5"). This ferrite is optimized for the VHF range (30-300 MHz). Fig 12 shows data for chokes wound around the same size toroid, but using a material optimized for suppression above 200MHz. The data of Fig 11 are for toroids of the same size, but wound on a material optimized for use below 2 MHz.

We'll study the $L_D C_D$ resonance first. A classic text (*Soft Ferrites, Properties and Applications*, by E. C. Snelling, published in 1969), shows that there is a **dimensional resonance** within the ferrite related to the velocity of propagation (V_p) within the ferrite and standing waves that are set up in the cross-sectional dimensions of the core. In general, for any given material, the smaller the core, the higher will be the frequency of this resonance, and to a first approximation, the resonant frequency will double if the core dimension is halved. In Fig 7c, L_D and C_D account for this dimensional resonance, and R_D for losses within the ferrite. R_D is mostly due to eddy current

(and some hysteresis) in the core.

Now it's time to account for R_C , L_C , and C_C . Note that there are two sets of resonances for the chokes wound around the #78 material (Fig 11), but only one set for the chokes of Fig 10 and 12. And for all three materials, the upper resonance starts just below 1 GHz for a single turn and moves down in frequency as the number of turns is increased. Fig 14, the reactance for the chokes of Fig 11, also shows both sets of resonances. That's why the equivalent circuit must include two parallel resonances!

The difference between these materials that accounts for this behavior is their chemical composition (called their mix). #78 is a MnZn ferrite, while #43 and #61 are NiZn ferrites. The velocity of propagation (V_p) in NiZn ferrites is roughly two orders of magnitude higher than for MnZn, and, at those higher frequencies, there is too much loss to allow the standing waves that establish dimensional resonance to exist.

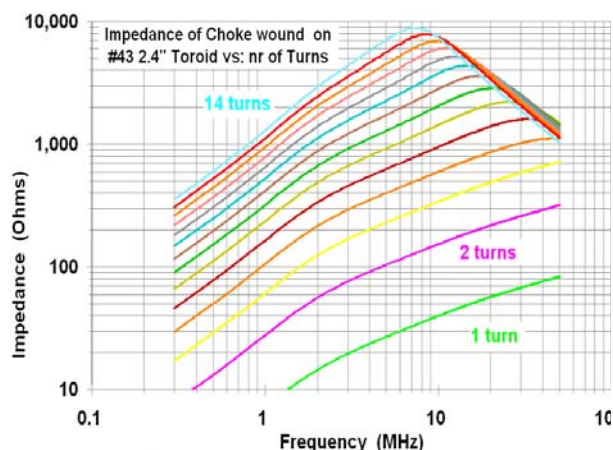

Fig 10 – Impedance of multi-turn chokes wound on the core of Fig 4 (Fair-Rite #43). (Measured data)

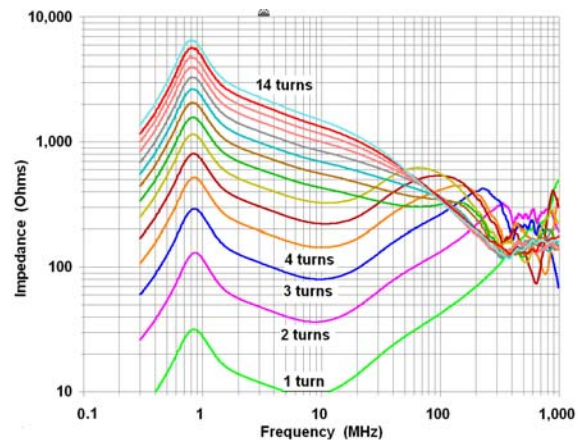

Fig 11 – Impedance of multi-turn chokes on a core of the size/shape of Fig 4, but of a material optimized for performance below 2 MHz (Fair-Rite #78) (Measured Data)

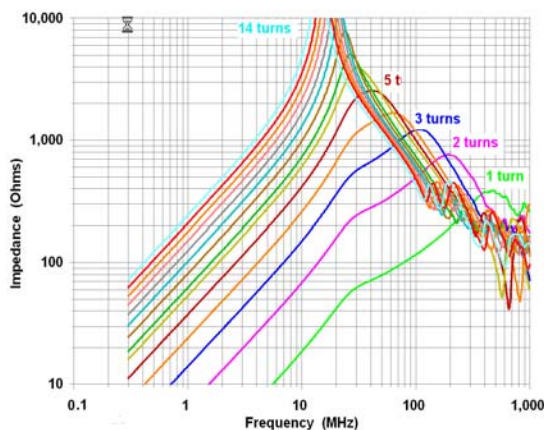

Fig 12 – Impedance of multi-turn choke on a core of the size/shape of Fig 4, on a material optimized for performance above 200 MHz (Fair-Rite #61). (Measured data)

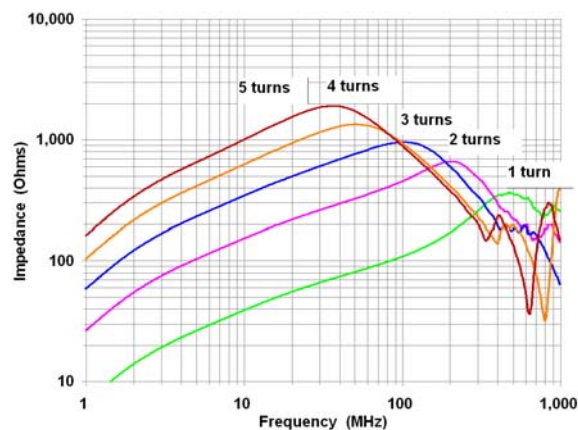

Fig 13 – Chokes of Fig 10 with 1-5 turns, measured to 1 GHz (Fair-Rite #43) (Measured Data)

Single Values For Permeability We see that μ varies with frequency, and is complex, yet those who don't understand this often use a single number for μ . When a single number for $\underline{\mu}$ is quoted, it is the value of μ at frequencies well below resonance, where losses are small and the graph of impedance is a straight line increasing linearly with frequency.

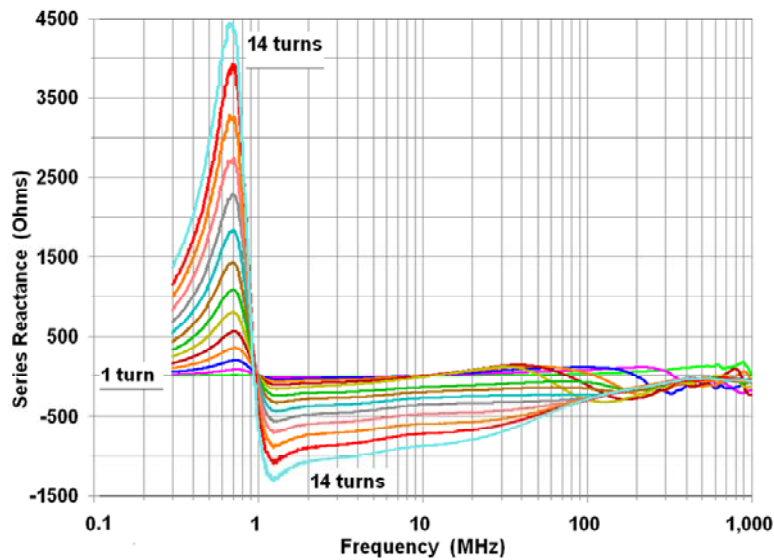

Fig 14 – Series reactive component of the chokes of Fig 11 (Measured Data)

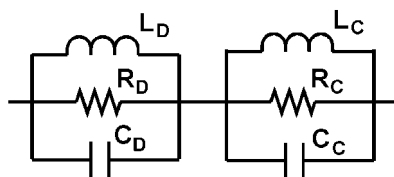

Fig 15
A multi-turn choke

To understand what’s happening, we’ll return to our first order equivalent circuit of a ferrite choke (Fig 15). L_C , and R_C , and C_C are the inductance, resistance, (including the effect of the μ of the ferrite), and stray capacitance associated with the wire that passes through the ferrite. This resonance moves down in frequency with more turns because both L and C increase with more turns. The dimensional resonance does not move, since it depends only on the dimensions of the ferrite and its V_p .

What is the source of C_C if there's no "coil," only a single wire passing through a cylinder? It's the capacitance from the wire at one end of the cylinder to the wire at the other end, with the ferrite acting as the dielectric. Yes, it's a very small capacitance, but you can see the resonance it causes on the data sheet.

Let’s talk briefly about series and parallel equivalent circuits. Many impedance analyzers express the impedance between their terminals as Z with a phase angle, and the series equivalent R_S , and X_S . They could just have easily expressed that same impedance using the parallel equivalent R_P and X_P BUT – R_P and X_P will have values that are numerically different from R_S and X_S . There is also an important analytical “mindset” we need to adopt when thinking about how series and parallel circuits behave. In a series circuit, the larger value of R_S and X_S has the greatest influence, while in a parallel circuit, the smaller value R_P and X_P is dominant. In other words, for R_P to dominate, R_P it must be small.

Both expressions of the impedance are correct at any given frequency, but whether the series or parallel representation is most useful will depend on the physics of the device being measured and how that device fits in a circuit. We’ve just seen, for example, that a parallel equivalent circuit is a more realistic representation of a ferrite choke – the values of R_P , L_P , and C_P will come much closer to remaining constant as frequency changes than if we use the series equivalent. [R_P , L_P , and C_P won’t be precisely constant though, because the physical properties of all ferrites – permeability, resistivity, and permittivity – all vary with frequency.]

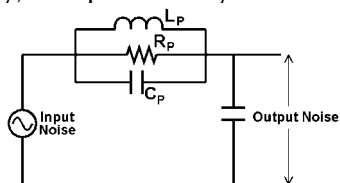

Fig 16a – Series element of divider is a parallel resonance circuit

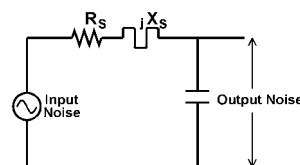

Fig 16b – Series element of divider is series equivalent circuit used for ferrite data sheet

But virtually all product data for ferrite chokes is presented as series equivalent R_s and X_s . Why? First, because it's easy to measure and understand, second, because we tend to forget there is stray capacitance, and third because ferrite chokes are most often used to reduce current in a series circuit! Fig 16a and 16b are both useful representations of the voltage divider formed by a ferrite choke and a small bypass capacitor across the device input. Which we use will depend on what we know about our ferrite. If we know R_p , L_p , and C_p and they are constant over the frequency range of interest, Fig 16a may be more useful, because we can insert values in a circuit model and perhaps tweak the circuit. But if we have a graph of R_s and X_s vs. frequency, Fig 16b will give us a good answer faster. Because we will most often be dealing with R_s and X_s data, we will use the series circuit for our remaining examples. Another reason for using R_s and X_s is that the impedance of two or more ferrite chokes in series can be computed simply by adding their R_s and X_s components, just as with any other series impedances! **When you look at the data sheet plots of R_s , X_s , and Z for a standard ferrite part, you are looking at the series equivalent parameters of their dominant resonance. For most MnZn materials, it is dimensional resonance, while, for most NiZn materials, it is the circuit resonance.**

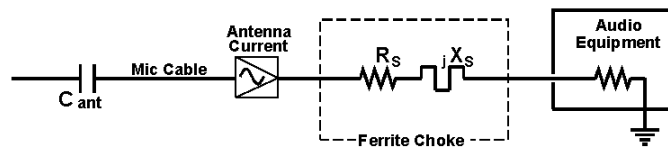

Fig 17 – The choke interacts with the cable

Fig 17 shows how a choke might be used to reduce common mode current flow on a cable. Because that cable is also an antenna, it will have some impedance of its own, depending on its length and the frequency of the interfering signal. If the antenna is shorter than a quarter-wave it will look like a capacitance, and can resonate with the inductance of the ferrite choke. When this happens, the current is limited only by the resistance of the circuit – in this case, the loss component of the choke plus R_R and R_{IN} (the radiation resistance and the input resistance). The choke can also be capacitive, and the antenna can be inductive, as it would be if it were longer than a quarter-wavelength. Antenna theory tells us that these impedance relationships will repeat in increments of $\frac{1}{2}$ wavelength. The last thing we want is to increase the RF current, and we would prefer to not have to worry about how long the antenna (mic cable) is.

Thus we state three general rules about the use of ferrites as chokes. **1) More impedance is better. 2) All ferrite chokes should be designed to operate in the frequency range where their series equivalent resistance is large and their series equivalent reactance is small. 3) These conditions are satisfied at or near the choke's resonant frequency.** We do this by selecting a suitable material, core size, and number of turns. These rules apply to both single turn and multi-turn chokes, and they apply to chokes (but not transformers) used for transmitting as well.

New #31 Material is a Problem Solver The relatively new #31 material made by Fair-Rite Products is extremely useful, especially if some component of your problem is below 5 MHz. Measured data for the new material is displayed in Figs 18a and 18b. Compare it with Figs 19a and 19b, which are corresponding plots for the older #43 material. By comparison, #31 provides nearly 7 dB greater choking impedance at 2 MHz, and at least 3 dB more on 80 meters. At 10 MHz and above, the two materials are nearly equivalent, with #43 being about 1 dB better. If your goal is suppression or a feedline choke (a so-called current balun), the #31 material is the best all round performer to cover all HF bands, and is clearly the weapon of choice at 5 MHz and below. Between 5 MHz and 20 MHz, #43 has a slight edge (about 1 dB), and above 20 MHz they're equivalent. We'll discuss baluns in detail in Chapter 6.

The new #31 material is useful because it exhibits both of the resonances in our equivalent circuit – that is, the dimensional resonance of the core, and the resonance of the choke with the lossy permeability of the core material. Below 10 MHz, these two resonances combine (in much the manner of a stagger-tuned IF) to provide significantly greater suppression bandwidth (roughly one octave, or one additional harmonically related ham band). The result is that a single choke on #31 can be made to provide very good suppression over about 8:1 frequency span, as compared to 4:1 for #43. As we will learn later, #31 also has somewhat better temperature characteristics at HF.

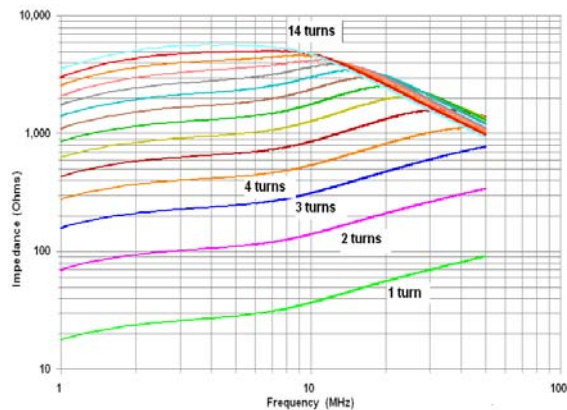

Fig 18a – Impedance of multi-turn chokes on a 2.4" o.d. toroidal core , but made of Fair-Rite's new#31 mix (Measured Data)

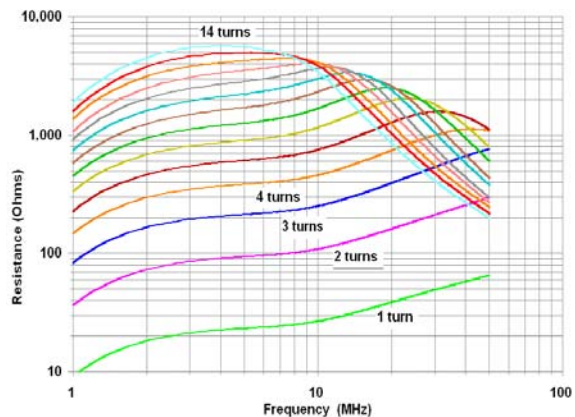

Fig 18b – Equivalent series resistance of the chokes of Fig 18a (Measured Data)

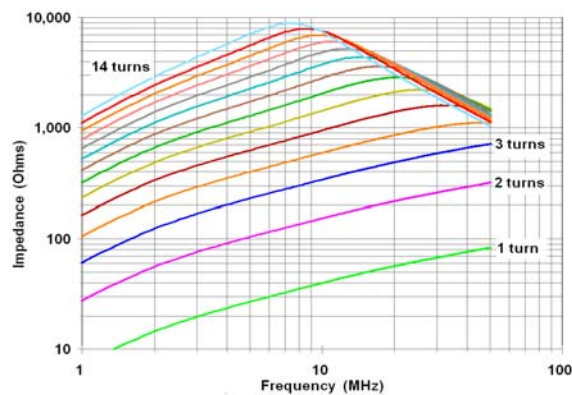

Fig 19a – Impedance of multi-turn chokes like those of Fig 16a, but on a Fair-Rite #43 core. (Measured data)

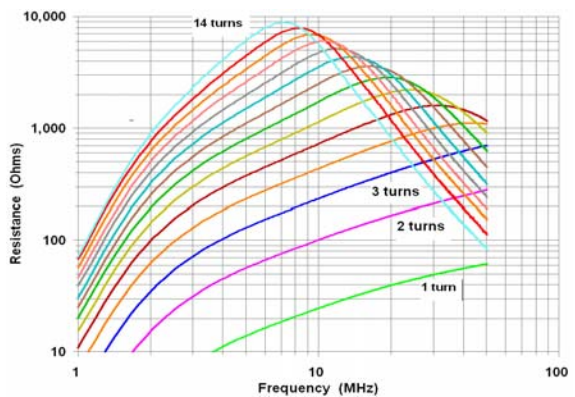

Fig 19b – Equivalent series resistance of the chokes of Fig 19a (Measured Data)

A simple design problem Now let's do some engineering work using what we've learned so far. Suppose that we have an Ethernet router that is radiating trash as a common mode signal on the Ethernet cable that we're hearing on 30-10 meters (as it turns out, this is a very common problem). Figs 18 and 19 tells us that 9 turns of the Ethernet cable around a 2.4" o.d. toroid made of Fair-Rite #31 or #43 material will give us at least 2k ohms choking impedance between 10 MHz and 30 MHz. How much that choke reduces the radiated noise will depend on a lot of factors, including the common mode output impedance of the router, how long the Ethernet cable is (and thus its impedance), and the common mode input impedance of the Ethernet device on the other end.

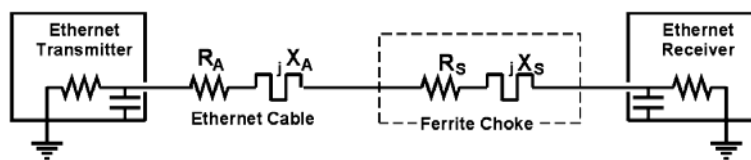

Fig 20 – Ethernet circuit

Fig 20 is a simplified equivalent circuit for our Ethernet problem. Note that it's drawn as if one device is a transmitter and the other is a receiver, but any box that includes digital or RF circuitry is a potential generator of RF trash. The common mode input and output impedances of the Ethernet boxes are unknown, and they have at least some connection, maybe DC, maybe capacitive, to the green wire at the AC outlet. Without the choke, the impedance of the antenna circuit (the Ethernet cable and its return path) determines the current. So to achieve good suppression, we simply need the impedance of the choke to be much higher than the series combination of the antenna and the paths to "ground." But – hold on a minute – what's hiding behind that ground symbol?

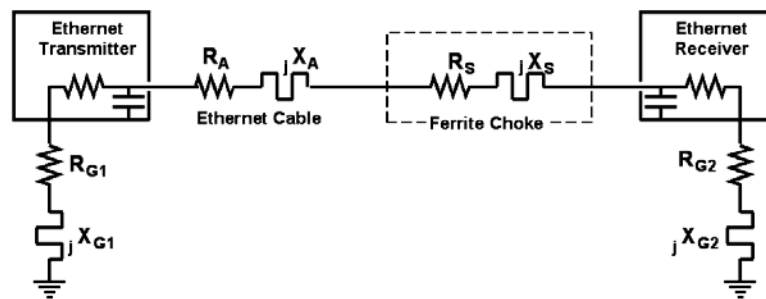

Fig 21 – Ethernet circuit, including "ground"

Fig 21, which includes the impedance of the path to "ground," makes it clear that there can be a lot of variables in this simple problem. Each of the X terms may be capacitive or inductive, and they will have different values at every frequency. Every wire in that series circuit will function as an antenna, radiating any noise current that it carries. Does that mean we must throw up our hands? Of course not. But it clearly shows why coming up with a number for how much suppression a given choke will yield is not a simple matter. Indeed, the best way to learn that for any given circuit is to wind a choke that provides the greatest impedance in a practical package and try it!

Do we need chokes on both ends of that cable? The answer is, it depends. The Ethernet devices on each end of the line are both potential generators of RF trash (because they both include digital electronics). We also need to look at the length of the series circuit that includes the Ethernet cable. If the cable is shorter than about $\lambda/10$ at the highest interfering frequency, a choke roughly near the center of the cable may be entirely sufficient. A cable that is electrically longer than $\lambda/10$ (or is radiating VHF trash) is far more likely to need chokes at both ends. And the chokes that work at VHF are very different from the toroidal chokes that work at HF.

In the simple circuit above, the Ethernet transmitter can be seen to feed an unbalanced dipole, where the Ethernet cable is half of the dipole and a connection to "ground" via the power supply is the other! Fig 21 makes it clear that the current path is also a loop. We must never forget that our invisible "ground" circuit can be part of the antenna circuit, contributing both its length and radiation to the problem. And if the Ethernet device is a switch or hub that has multiple outputs, the Ethernet cables connected to each port become part of the equivalent circuit, and because each output includes a line driver, the cables connected to each output need suppression.

The dc power supply for that Ethernet router may also be a source of noise, and there are two antennas connected to it – the AC power line and the dc power cable going to the router. Are either or both of these cables likely to need treatment? To answer this question, let's look at their likely behavior as antennas. In a typical home, the AC power line is probably 30-50 ft long by the time it reaches the breaker panel that feeds it, which is long enough to be a pretty good antenna on 10-30 MHz, so my next choke would go on the power line side of that power supply. On the other hand, the cable between the power supply and the router is only 3 ft long, which means that it is unlikely to be a good antenna below 30 MHz. So if I hear any noise on 10 meters after I've put chokes on the Ethernet cable and the power line, I'll try a fairly small choke (7 turns around #31 or #43) on the dc power cable.

Ethernet trash comes in (at least) two common forms – *multiple carriers* of relatively constant amplitude, but with some modulation (birdies), and *broadband hash*. The clocks are generated within the Ethernet hardware, so frequencies vary slightly from one Ethernet box to another. In almost any residential neighborhood, you'll hear clusters of Ethernet birdies around 10,107 kHz, 10,122 kHz, 14,030 kHz, 18,106 kHz, 18,120 kHz, 18,167 kHz, 21,052 kHz, 21,113 kHz, 21,174 kHz, 21,221 kHz, 21,282 kHz, 21,343 kHz, 24,878 kHz, 24,945 kHz, 28,016 kHz, 28,060 kHz, 28,120 kHz, 28,182 kHz, 28,244 kHz, 28,304 kHz, 28,366 kHz, 28,427 kHz, 50,044 kHz, 50,058 kHz, 50,105 kHz, 50,120 kHz, 50,148 kHz, 50,166 kHz. There are certainly more, but these are some I've found (nearly all of my operation is CW).

In any cluster, some birdies will be louder than others, depending on the behavior of the Ethernet cables as antennas, the nastiness of the Ethernet boxes, and the proximity to your antennas. **Be-**

fore you begin cleaning up your own trash, identify which signals are yours by killing power to your own router, switch, or hub. This is important, because even after you've killed your own trash, you're likely to hear your neighbors (hopefully at much lower levels). If you don't know which are yours, you can end up chasing your tail. And you may not be able to completely kill your own – most of these boxes are poorly shielded, so some trash can be radiated by internal wiring.

Chapter 3 – Back to the Basics

Threshold Effect Looking again at the series circuit of Fig 21, let's say that for a particular antenna (Ethernet cable) working into a particular piece of gear, the series impedance at the frequency of the interference is $300\ \Omega$. If we are able reduce the RF current by 6 dB, (one half), the interference radiated by that cable will also drop by 6 dB in our ham receiver. To do that, a choke must add enough resistance to double the total impedance. In other words, we need to end up with $600\ \Omega$. But what if the antenna circuit is capacitive and our choke is inductive at that frequency? Some of the impedance we are adding will increase the current because it resonates with the antenna, so we may need to add more than $300\ \Omega$ to hit $600\ \Omega$! *How many times have you heard someone say, "ferrite beads don't work on this problem – I added one and nothing happened."* In fact, they were simply below the threshold impedance needed in that particular circuit! Once we've hit that threshold, adding more series impedance continues to reduce the current flow. RF current is reduced by the ratio of the "before" and "after" values of the total series impedances. Since power is proportional to the square of the current, RF noise falls 6 dB per halving of the current flow. If the choke is suppressing the detection of RFI in other equipment (telephones, hi-fi systems, etc.), 6 dB less RF translates into a 12 dB reduction in detected RF (because all detection is square law).

Threshold effect is the reason why adding a few clamp-on beads doesn't make a dent in RFI at HF—you need turns to hit the threshold!

Human Perception and Level Changes When a sound is not near the noise floor (or much louder than other sounds), 1 dB is approximately the smallest change in loudness that most people can hear, and a change of about 10 dB will be perceived as half (or twice) as loud. When a sound is close in loudness to other sounds, (room noise, or the band noise when we're trying to copy weak DX), a change of a few dB in one of those sounds may be heard as half (or twice) as loud.

Chokes May Be Used in Series and their impedances will add algebraically (that is, taking the sign of the reactance into account). For many years, "current baluns" have been made of many ferrite cylinders at the end of piece of coax. This so-called balun is really a common mode choke, and its common mode impedance is simply the impedance of one cylinder multiplied by the number of cores. Baluns are addressed in detail in Chapter 6.

Suppression at VHF Let's suppose that we have a problem with RFI on 2 meters. The most common way to provide suppression at VHF is with one or more clamp-on cores like those of Fig 8 or Fig 22. A good "rule of thumb" is that it usually takes at least 500-1,000 ohms to get far enough above the threshold to "make a dent" in RFI, and more is better. Using that guideline, three of these cores might be needed for a problem on 2 meters if there isn't already another choke in line.

There's usually more than one way to skin a cat though – Fig 23 shows that we might get close with 2 or 3 turns around our old standby #31 or #43 toroids, especially if we already have an HF choke in place to contribute its impedance.

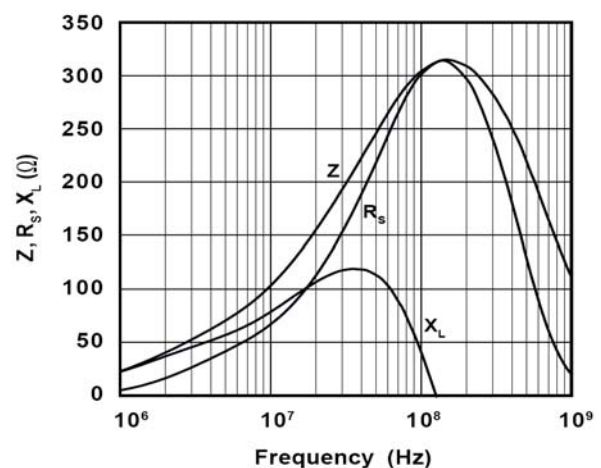

Fig 22 – A #31 Fair-Rite "clamp-on" ferrite, 1.5" long with an i.d. of 0.275"

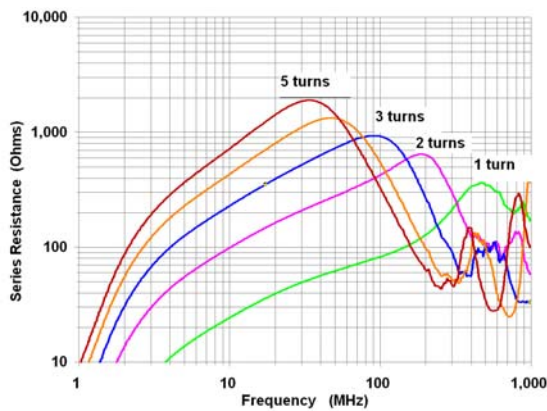

Fig 23a – Equivalent series resistance of multi-turn chokes on a Fair-Rite #43 2.4" o.d. toroidal core (Measured Data)

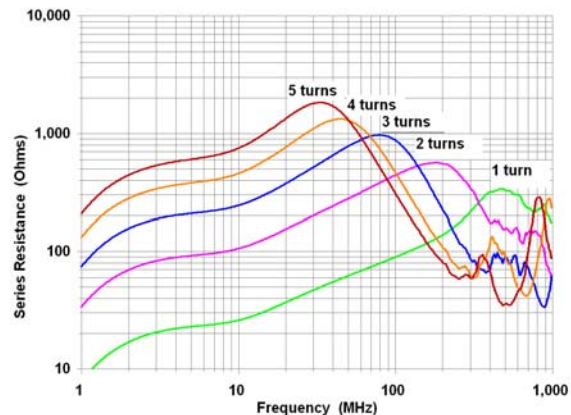

Fig 23b – Equivalent series resistance of multi-turn chokes on a Fair-Rite #31 2.4" o.d. toroidal core (Measured Data)

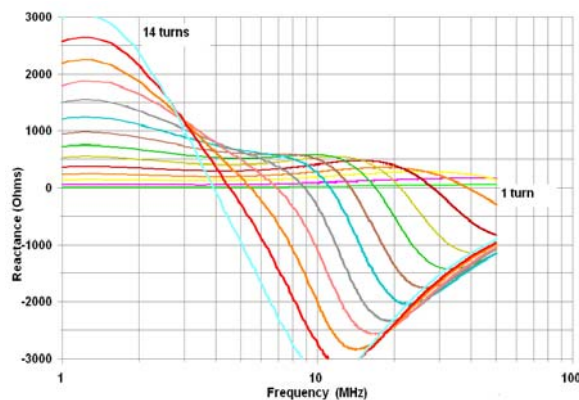

Fig 24a – Equivalent series reactance of multi-turn chokes like those of Fig 18, a Fair-Rite #31 core. (Measured data)

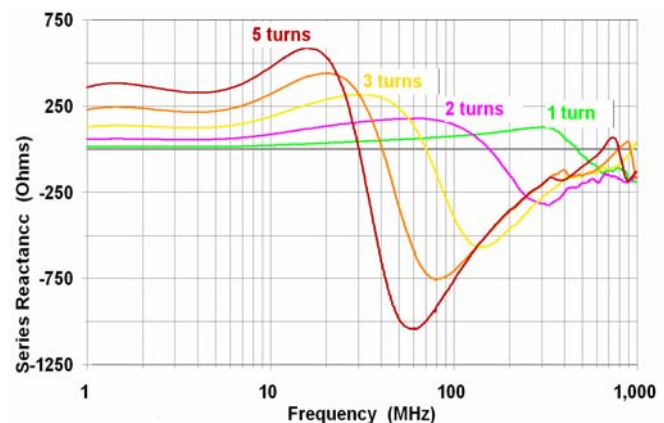

Fig 24b – Equivalent series reactance of chokes on #31 toroids of Fig 23b (Measured Data)

Note: All of the data presented up to now applies to chokes wound with small diameter wire. Chokes wound with cable diameters larger than about 0.2" (RG58) have more stray capacitance, moving the resonance down to a greater extent than those wound with small wire. See Figs 41 – 46 for data on some chokes wound with RG8 and RG8X.

Using Different Chokes in Series All ferrite chokes along a cable do not need to be identical – indeed, in broadband suppression applications it may be necessary for them to be very different. But we must remember that the complex impedances of these chokes (that is, their resistive and inductive or capacitive elements of their series equivalent circuit) will add algebraically, so we must consider the magnitude and the sign of the reactive components of each choke. Again, the fundamental principle of using ferrite chokes for suppression comes into play – **resistance always helps us, but reactance may make things worse. When adding up the total impedance of multiple chokes, the safest approach is to count only the series equivalent resistance of each choke.**

For example, consider a cable wound 5 turns around a toroid to provide good suppression for the HF ham bands. Fig 23a and 23b show measured series resistance, while Figs 24a and 24b clearly show that the impedance of these chokes is capacitive above resonance, just as we would expect from Fig 15. Now, we add one or more of the clamp-ons shown in Fig 22. Between 30 and 100 MHz, the clamp-on is below resonance, so it looks like a lossy inductance. Thus, with both the VHF clamp-ons and the toroid in series on a cable, there will be some cancellation of their reactances in this range, **but their resistive components will always add** (improving the suppression).

When using multiple chokes to cover different frequency ranges, always place the choke covering the highest frequency range nearest to the equipment being protected. The wire between the

equipment and that choke can still function as an antenna.

Large Signal Performance Up to now, we've talked only about the "small signal" behavior of ferrites – that is, the field produced by current in the ferrite material is too small to cause *heating* or *non-linearity*. We can define a *linear* device as one that has the same impedance for all values of applied voltage and current. Like other magnetic materials, ferrites will saturate at some high level of current. In other words, the ferrite behaves linearly if the field within it is small, but becomes non-linear as it begins to saturate.

DC Bias As a magnetic material approaches saturation its permeability decreases, approaching zero at saturation. Consider a ferrite surrounding a conductor carrying both signal and a DC current. The total field at any instant is the result of the instantaneous current, so if the DC current is large, it can move all or part of the signal into the non-linear region of the ferrite. The DC bias can also cause heating.

Non-Linearity is generally a bad thing, because it causes distortion. That distortion will take the form of harmonics for a simple waveform (a constant sine wave of a single frequency) and both harmonics and intermodulation products for a complex waveform (a keyed sine wave, or transmitted audio). We'll talk more about this in our discussion of transmitting baluns and chokes.

Non-Linearity as a Tool Non-linearity isn't always bad. Bob Kavanagh, VE3OSZ, showed how the inductance of a coil wound around a toroid could be varied by controlling DC bias applied to the coil. In this application, both the bias and the signal were sufficiently small that non-linearity was also small. [*"Remote tuning of a low-frequency loop antenna,"* QEX May/June 2003]

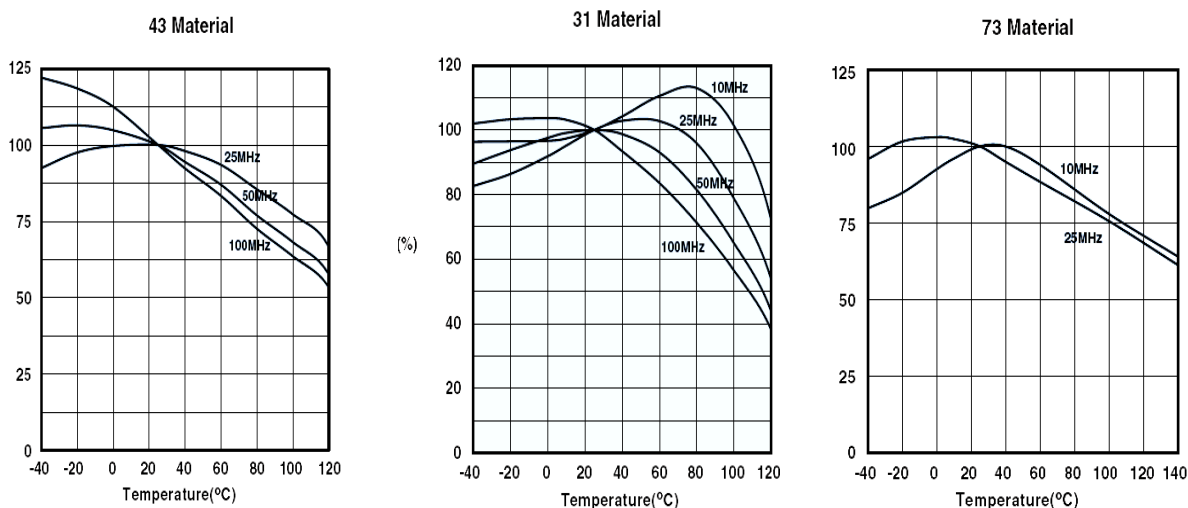

Fig 25 – Impedance vs. Frequency and Temperature as a percentage of impedance at 25°C

Temperature The permeability of ferrite materials varies as a function of both frequency and temperature, and different mixes behave very differently (Fig 25). Any RF current that produces a field in the ferrite will cause heating in the ferrite (and IR losses in the wire). If the current is small enough, the heat will be radiated and/or conducted as fast as it is produced. Larger currents, however, can cause temperature to increase. At some high temperature (the Curie temperature), the ferrite will temporarily lose its magnetic properties (until it cools). The Curie temperature is different for each mix. In the #43 and #73 materials, this will in turn cause permeability to fall, which in turn allows more current, which produces more heating. In other words, thermal runaway can occur if the current is large enough and the core is small enough.

The #31 material has somewhat better temperature characteristics, especially on the lower HF bands, where impedance actually increases with temperature up to about 100°C, but a rather low Curie temperature. Thermal runaway can still occur, but is a bit less likely. *In general, it is important to use ferrites in a manner that 1) saturation is avoided, and 2) permeability does not significantly drop with temperature.* We'll talk more about this in our discussion of transmitting chokes.

Total Field A ferrite sees the instantaneous algebraic sum of the fields produced by the currents in all the conductors that it surrounds (or that are wound through it). If, for example, a ferrite surrounds two conductors carrying currents that are equal and opposite, (for example, "hot" and "return" of a power circuit, loudspeaker line, or RF transmission line), the total field will be zero. When the currents are not equal and opposite, the ferrite sees the field resulting from that difference (that is, the common mode current). *This means that we can use relatively small ferrites to suppress small common mode currents on paired cables that are carrying large differential currents as long as the ferrite surrounds all the conductors.* We'll show applications of this later on.

Chapter 4 – More Suppression Applications

Mobile Operation Common mode noise on the DC power line can be suppressed by winding turns of both conductors around a ferrite core. But: if DC return current divides between the dedicated DC negative lead and the shield of the coax going to the antenna, the DC component of the flux in the ferrite core will not be zero, and if it is large enough, the choking impedance is reduced.

Ferrite chokes can also be used on only the positive DC conductor to provide differential mode suppression. In a modern vehicle, we have two very different problems. When receiving, we are concerned with noise from the vehicle's electronics causing interference to our radio, but the DC current to the radio is small (typically 1-2A). When transmitting, we are concerned with our radio causing interference to the car's electronics, and in this condition, our 100 W radio is drawing 15-20A. In Chapter 3, we learned that DC current can cause some reduction in the impedance of a ferrite choke. The obvious question is, "How much is the impedance reduced?"

Quantifying the Reduction in Impedance with DC Current The Fair-Rite catalog provides data for the H-field in Oersteds for 1 Ampere-Turn for many of their products. The applications section at the end of the catalog includes families of curves showing how the impedance of each material (mix) is reduced as a function of field strength and frequency. (Fig 26)

A Design Example: Ten turns of the positive DC lead for a mobile transceiver is wound around our standard #31 2.4" toroid, and the DC current for our mobile transceiver is 1A on receive. The catalog tells us that H is 0.09 oe for 1 Ampere Turn, so $H = 0.9$ oe in our 10-turn choke, which reduces impedance to 40% of the measured value at 10 MHz and 50% at 25 MHz. If we were to re-plot the data with H as constant and frequency on the horizontal axis, we could extrapolate impedance of about 32% at 5 MHz. Applying these correction factors to the data of Fig 18a tells us that with 1A of bias, we could expect our 10 turn choke to look like about 1,100 Ω at 5 MHz, 1,600 Ω at 10 MHz, and 2,000 Ω at 20 MHz. This is still a fairly reasonable choke, and should provide reasonable noise suppression for receiving. When transmitting, however, this choke will be severely saturated, reducing its impedance to about 250 ohms at 10 MHz. Thus, if we suspect transmitter RF coupling via the radio's power lead to the automotive electrical system, we would use a larger ferrite part – one that has a much larger cross sectional area for flux, like the "big clamp-on" of Fig 38.

A Home Entertainment System What if the problem is RFI to a home audio system from operation on 80-10 meters? *The first thing we should do is look at the loudspeaker wiring, and if it is zip cord, replace it with twisted pair.* If we still have interference, it's likely that common mode current on one (or more) of the cables is exciting a pin 1 problem. We need to determine which frequencies we're still hearing, decide which cables connected to that system are the best antennas at those frequencies, and add chokes to those cables.

In the system of Fig 27, the cable between the CD player and the receiver is probably quite short, and if both units are plugged into the same outlet, the loop through the power system is likely to

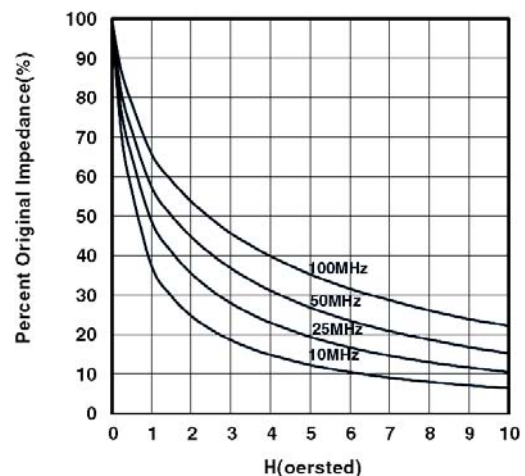

Fig 26 – Reduction of Impedance with DC Current (Bias) Fair-Rite #31 Mix

be fairly short. Depending on how the system is set up, the video cable may be long or short. On the other hand, the coax coming from rooftop TV antenna of the CATV system (including the download for the CATV system) may be fairly long. Both are likely to be pretty decent receiving antennas. In this system, I would first try 8-10 turns of the coax around a #31 toroid, because it looks likely to be the most effective receiving antenna for my 3.5-30 MHz station. But don't rule out shorter cables for the higher bands – the cable connecting the CD player was the culprit for 10M RFI in my own living room.

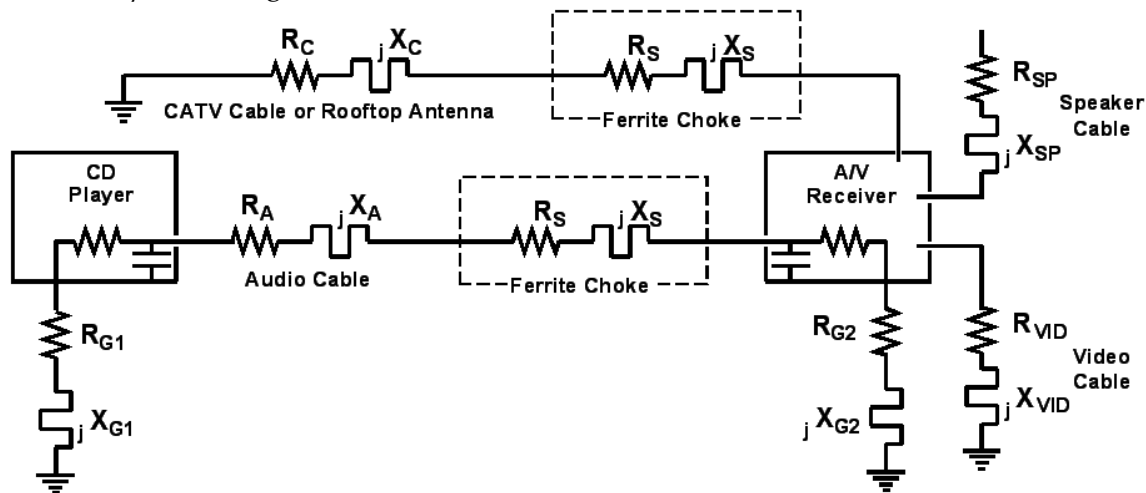

Fig 27 – A simple home A/V system

CATV and Rooftop Antenna Downloads Tom Rauch, W8JI, has outlined an excellent (and very simple) strategy for lightning protection that also puts an effective band-aid on pin 1 problems when the interfering signal is on the HF bands and is being coupled by coax from a roof-mounted antenna or CATV system. Tom bonds the coax shield to the green wire of the power cord at the power outlet for the entertainment system, then extends it to the A/V system. This causes the primary path to "ground" for shield current to bypass the home entertainment system and go straight to the power system "ground." The only problem with this approach is that you probably need to build some sort of simple connector box to implement it.

Interference At VHF is always coupled either directly into unshielded equipment, or onto wiring that is very close to the equipment. Fair-Rite #43 or #31 materials are the best choice up to about 200 MHz. Above 200 MHz, Fair-Rite #61 material or Steward HF material are the weapons of choice. The resonance of a single turn through a #43 or #31 core is typically about 150 MHz; 2 turns brings the resonance below 90 MHz and double the impedance at the resonant peak; 3 turns brings it below 60 MHz and double it again. Thus, the 0.3" and 0.5" i.d. cores make very good suppression chokes at 50 MHz (2-3 turns) and 144 MHz (single turn, multiple cores in series).

Use Your Talkie as An Injection Probe to locate the susceptible components and wiring in a system that is experiencing VHF interference. A talkie that has a relatively sharp turn-on transient (for example, the Kenwood TH-F6A) when you key it works best. To use it, find a channel where you won't cause interference near the frequency where your radio is getting into the equipment, set the radio to transmit at full power, and key the PTT switch on and off continuously as you move it around the susceptible equipment and its wiring. Move the talkie's antenna at least a wavelength or two along each cable connected to the susceptible equipment – it's normal to find one or two hot spots at quarter and half wave increments along the cable. If the interference is very strong, reduce transmit power to "zero in" on the susceptible points. When you find sensitive wiring, add one or more ferrite chokes as close to the equipment as practical. Wiring between the choke and the equipment will still function as an antenna. And remember threshold effect – multiple chokes may be required to hit and exceed the threshold.

Most RF Susceptibility is Frequency Dependent Equipment may be free of problems on some bands but have serious problems on others. This is not surprising – we know that the unintentional antennas that couple interference work better or worse depending on their length, orientation,

proximity to our transmitting antennas, and many other factors. The coupling paths into equipment are often frequency-dependent, as are the paths inside the equipment that lead to the semiconductor junctions where detection takes place. This means that your talkie may not be much help in probing equipment for RFI problems on the HF bands.

Equipment Shielding If you've killed all the RF coming in on the cables and there's still a problem, chances are it's poor shielding of the equipment, and for that, you'll need the bucket. Nearly every powered loudspeaker I've ever seen has been a shielding and pin 1 nightmare. You can fix pin 1 with ferrites. Be sure to duck when you tell your neighbor you need to use the bucket.

Advanced Troubleshooting – Dummies Typical home entertainment systems have several blocks in the signal chain and interconnections between them. Several pieces of gear could be detecting the RF, and pin 1 problems are the most common mechanism. Pin 1 problems are excited by shield current, so if we try to isolate a problem to a piece of gear by disconnecting it, we may get false clues because we've interrupted the RF current path with the disconnection, not because we've found the problematic equipment.

Bill Whitlock developed an innovative solution to this dilemma, in the form a cable adapter he calls a "dummy." The dummy is very simple, and easy to build. It can take two forms. One is a "barrel" adapter, with a male connector on one end and a female on the other. There is no connection between the male and the female, except for the shield contact. The female connector has a 10K resistor between "hot" and "return," while the male has a low value resistor (270-470 ohms) between hot and return. If the connector is unbalanced, return is the shell. In a balanced connector, it's the other signal lead. If a barrel connector is not available, we can use the other practical form of a dummy – a pair of male and female connectors with a cable connecting only their shields together and the resistors within each connector.

To use the dummy, insert it at various points in the signal chain and note whether the interference is present or not. Since there is no signal connection between the two ends of the connector, any detected RF that you're hearing must be getting detected downstream of the dummy. If you then break the connection to the dummy and the hum, buzz, or RF goes away, you know that there is hum, buzz, or RF shield current at the point where you broke the connection. Dummies are especially useful in chasing RFI on the HF bands where the talkie doesn't help.

RFI to Telephone Systems Telephone wiring is an effective receiving antenna for the HF bands, and most consumer telephone products have poor immunity. Again, the path for antenna current is through the phone and its power supply to "ground." Phones often have both common mode and differential mode susceptibility. Ferrite chokes can reduce the common mode coupling, but differential coupling calls for a capacitor with good RF characteristics across the telephone line. This capacitor shouldn't have too high a value – if it does, it could degrade the audio response – and the leads must be very short.

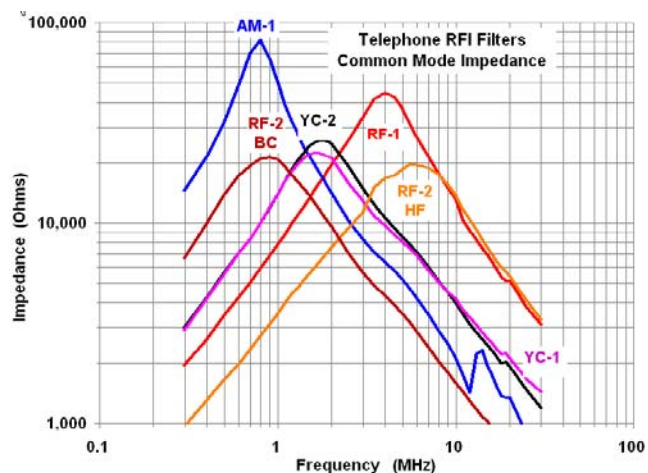

Fig 28-Common Mode Chokes for Telephone Lines

Remember that twisted pair wiring inherently rejects RF and noise coupling, and the better the quality of the twisted pair, the better the rejection. CAT5/6 cable works very well for telephone wiring – it is plentiful, inexpensive, easy to work with, and has both a very high twist ratio and very good bandwidth. Replacing existing telephone wiring with twisted pair is a very good first step.

Fig 28 shows measurements of some common mode chokes that are known to be effective in suppressing of RFI to telephones from HF transmitters. The thing that all of these filters have in common is very high common mode impedance. Filters AM-1 and RF-1 are sold by John Browne,

KI6KY <http://www.ky-filters.com/> Filters RF-2 and RF-2 BC are K-Com filters. Pete Krieger, K8COM, the manufacturer of the K-Com filters, has closed his business and retired. Filters YC-1 and YC-2 are my own design, and will be most effective on 160M and 80M. YC-1 is 30 turns of the telephone cable wound on one 2.4-inch #31 toroid. YC-2 is 22 turns wound on two toroids. For 40M or 30M, start with one 12-turn choke and add a second in series if needed. The RFI-1 KY filter should be effective on the HF bands.

RFI to DSL Modems DSL modems utilize the RF spectrum between about 25 kHz and 2MHz. Begin by using CAT5 for as much as possible of the wiring that carries the DSL signal, especially wiring that is exposed to interfering transmit antennas (including any radial system). Next, add YC-1 or YC-2 filters to every cable connected to the DSL modem, including its power supply. In your station, use a coaxial transmitting choke having at least 5,000 Ω choking impedance at the feed-point of every transmitting antenna. Make sure that your tower ground, power system ground, telephone system ground, CATV ground, and shack ground all have a low impedance bond to a single point that is then bonded to all earth electrodes.

If interference persists, differential filtering may be required. Use a low-pass filter with the highest practical cutoff frequency, taking into consideration the ham bands on which you will transmit. For example, if you use 160M, design the filter for a cutoff around 1.5 MHz; if 80M or 40M is your lowest band, use 2.5 MHz, and 5 MHz if 40M is the lowest band. Paired audio cables, including telephone cables, are not 600 ohms – their characteristic impedance is 80-100 ohms, so the filter should be designed for 90 ohm source and load impedances. A very nice filter design program, SVCFilter, is included on the CDROM that accompanies the ARRL Handbook. It can also be downloaded from. <http://www.tonnesoftware.com/svcfilter.html> Set it for a 90 ohm design impedance. Carefully study the filter response to see if there's any variation in the time response in the passband. If there is, use a different filter configuration – more poles, a higher cutoff frequency, a different filter type – that minimizes the variation.

Doorbells, Smoke Alarms, etc. Coupling of RF into these products is often differential mode. When it is, a good RF capacitor across the terminals is usually an effective fix. 0.1 – 0.47 μ F will usually do the job. Be sure that the voltage rating of the capacitor is sufficient – study product documentation to see what voltages are used. Most products like this use 12-24 volts for control.

Don't rule out the possibility of replacing the wiring for these systems with good twisted pair cable – if you can get at the wiring. Shielding is not usually important, but twisting is. In addition, foil/drain cable shields can actually cause RF interference in twisted pair cables – see the tutorials about shield-current-induced noise (SCIN) at <http://audiosystemsgroup.com/publish.htm>

Suppression "At the End of the Line" Some devices that receive interference have only one set of wires connected to them, counting the power supply, so there is no path for RF current through the device. An example might be a smoke detector that has built-in electronics but no power supply – instead, it obtains its power from the same cable that connects the sensor to a main unit. When the device is at the end of the line, there is no path for common mode current to flow through the device, so the interference is almost certain to be coupled in the differential mode (that is, between the terminals of the signal wiring or the power wiring). "End of the line" interference cannot be suppressed with a choke – there is no RF current to suppress.

Most 'end of the line' problems are solved by a capacitor across the line to short out the interference. The capacitor must not be so large that it weakens or distorts the waveform of the desired signal, but large enough to reduce the strength of the RF signal. In some cases, a low pass filter may be required.

More than One Coupling Mechanism Most cases of interference are coupled by more than one mechanism. The total interference will be the algebraic sum (that is, considering both magnitude and phase) of all of the interference mechanisms that are at play in that particular system. Usually, but not always, one will be dominant, and when it is eliminated, interference from the others may still be heard. We may, for example, kill the common mode current with a choke and reduce the interference, but there may still be some differential mode interference present that needs a capacitor across the signal line to kill it. There may be more than one common mode current path,

as in the examples of the Ethernet equipment and the home entertainment system.

Twisted Pair Cable I can't say it enough – *zip cord is terrible for RFI, and twisted pair solves many problems*. If you have RFI and the cable is anything but coax or a good twisted pair, try to replace the cable. This is true for virtually all systems – anything from the sensor for a smoke detector to telephone wiring to big loudspeaker cables. Shielded cable rarely solves RFI problems, partly because to do anything useful cable shielding must continuous with equipment shielding, and lots of equipment to which you would like to connect it is unshielded!

Cylindrical vs. Snap-On Cores As you can see from the data (Appendix 1), cylindrical cores perform much better in the lower HF spectrum than equivalent Snap-On cores, but only about 10% better at VHF. The Snap-On cores are also nearly double the cost. Their principle advantage is their ease of use – you can fit them onto a lot more cables without taking the connector off.

Fair-Rite Data for 1-3 Turns Since I first published my work about five years ago, Fair-Rite has updated their online catalog with impedance data for 1, 2, and 3 turns through many of their suppression components. To access it, click on a part number to see a detailed data sheet, then scroll down to the bottom and click on Impedance Curve.

Estimating the Performance of Multi-Turn Chokes Without Measured Data Unfortunately, other manufacturers don't publish much data for multi-turn chokes, and even Fair-Rite data only goes up to three turns. Beyond that, the measured data that I have published is nearly the only publicly available data on multi-turn ferrite chokes! You can, however, begin with published data and use our data as the basis for "guestimating" how another part will behave with multiple turns.

Suppress Differential Mode Interference in FM and TV Receiving Antennas with traditional high pass, low pass, bandpass, and bandstop filters. Tin Lee Electronics, near Toronto, makes a broad selection of filters. www.tinlee.com Install the filter upstream of the first electronic device that is being overloaded by the interference. In Chicago, I used a bandpass filter on the FM-only antenna and a high pass filter on the TV antenna (in addition to common mode chokes on both antennas). Also, remember that after the DTV conversion, there are almost no TV stations operating below Channel 7 (174 MHz), and most are on UHF channels, so a high pass filter that cuts off above 2M should be sufficient. Study <http://www.fcc.gov/dtv/markets/> for your area.

Chapter 5 – Suppressing Interference To Your Ham Station

In addition to the weak signals of the DX we're trying to work, our ham antennas are bombarded with RF trash from a plethora of electronic devices, electrical appliances, and other equipment, both within our own homes, and in the surrounding neighborhood. The noise may be conducted on the power line, and it may be radiated both by power wiring and by other antennas connected to the noise source. Common noise sources include computers and computer peripherals, computer network hardware, power supplies for equipment, battery chargers, AC-AC converters for low voltage lighting, electric fences, and motors.

Power Line Filters Since the power line is often both a conductor and a radiator of noise, we need to know how to take it out of the picture effectively. Most noise sources couple both common mode and differential mode signals, so both need to be addressed.

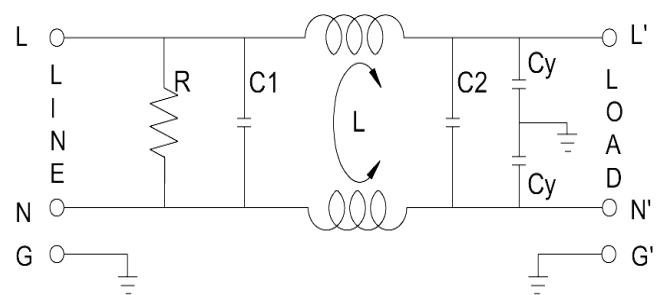

Fig 29a – Commercial Line Filters, and a typical schematic

Commercial AC power line filters (Fig 29a) typically include both common mode and differential mode filtering. Like most products, line filters are built to a wide range of performance levels to fit needs and budgets. Like any passive network, line filters are directional, because their operation depends on both source impedance and load impedance (but thanks to the impedance relationships, they don't work *equally* well in both directions). For data and photos for more filters I found at a local surplus house, see <http://audiosystemsgroup.com/PowerFilters.pdf> .

In the schematic of Fig 29a, the inductor is a common mode choke. C1 and C2 function as voltage dividers with the imbalance and leakage inductance of the choke to form a differential mode filter. C1 minimizes noise coupling from load to line, while C2 minimizes coupling from line to load. The two capacitors C_y form a common mode filter for noise coupled from the power line to the equipment. C_y must be small in value to satisfy electrical safety codes, which limit leakage current to about 5 mA – 4.7 nF is typical. Typical values for C1 and C2 are 0.22 – 0.47 μF .

Specifications for most good commercial filters are available on line. Study them carefully when choosing a filter. Note that these data are for a 50 ohm source and load network (called a LISN) specified by the FCC. While the LISN make the filters relatively easy to measure, it is a somewhat fictional representation of the real world – it is, in essence, the "mean" of data for typical power systems. The common mode impedance of a typical power system branch circuit ranges from about 30 ohms to about 300 ohms at radio frequencies. Because filters work by forming voltage dividers, two elements of which are their source and load impedances, the performance of any filter can vary widely from its published specifications, and will be better if the source impedance (at radio frequencies) of the AC line is lower.

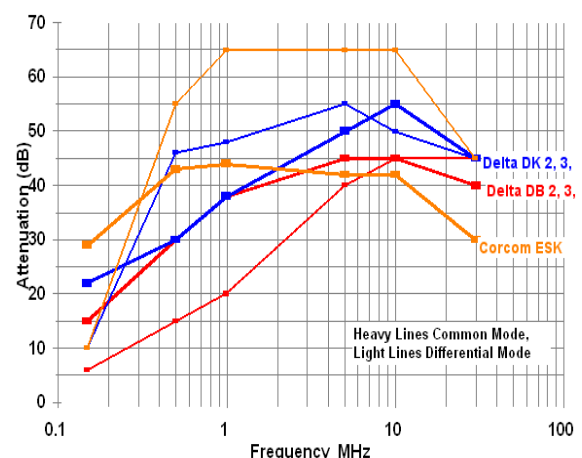

Fig 29b – Published Specifications for Some Small Power Line Filters

Fig 18b suggests that the filter shown in Fig 30 should provide about 3k Ohms R_s between 2 and 10 MHz, and tests with some noisy low voltage lighting equipment correlated well with this prediction. It is less effective at higher frequencies, because its stray capacitance places its resonant frequency in the 10-20 MHz range, thus tending to short out the loss component of the choke above that range. This could be addressed in several ways. First, the wire is larger than needed for most applications – most AC line cords are built with #18 wire. Winding the choke with #18 wire would likely raise the resonant frequency a bit because the turns could be less "jammed together". Alternatively, a second choke with fewer turns could be added in series with the first one. Fig 18 and 19 suggest that 7 turns on #31 or #43 should work well.

A Home-Brew Filter The "brute force" line filter of Fig 30 provides effective line filtering for the lower HF bands (10 MHz and below). The choke is wound with a twisted pair of #12 THHN stranded wire on a #31 2.4" o.d. core, so it can be safely used in a 20A circuit. As in the commercial filters, the capacitor forms a differential mode filter with the imbalance in the inductance of the choke, and should always be on the end of the filter opposite the noise source. Since only the "phase" (hot) and neutral conductors pass through the choke, the equipment ground conductor (green wire) must be carried around the filter (that is, from power source to load). The capacitor should be about 0.47 μF , Only Type X1, X2, Y1 and Y2 capacitors, which are specifically tested to withstand the high voltage spikes that



Fig 30 – A line filter for 1-14 MHz

can occur on power wiring should be used. Choose this capacitor carefully – if it fails, it could catch on fire!

Using Line Filters A line filter should be always as close as possible to the source of the noise so that the loop area (and antenna length) of wiring carrying the noise current is minimized. The home I bought here in California came with several low voltage lighting fixtures, all of which use very compact, and very noisy, 120 VAC to 12VAC "electronic transformers" (switching power supplies) that fit in the ceiling backbox for the lighting fixture. I tried two approaches. Both work fairly well – *if you can fit the filters where you need them.*

Method #1 – build the ferrite choke of Fig 30 and cram it into the backbox. This choke works electrically – it completely eliminated noise from very nasty power supplies that was radiating into my 160/80 meter vertical only 30 feet away. Unfortunately, it doesn't fit inside the backbox, so I would need to shove it into the ceiling behind the backbox. Fire safety considerations suggested that I try another approach.

Method #2 – mount a suitably small line filter to the back side of the metal plate that mounts the nasty 120-12V "electronic transformer" to the backbox, and connect it in series with the AC line by the shortest practical leads. This works mechanically, and it works well enough electrically that while I hear a bit of noise on the vertical, I don't hear it on the high dipole at about 100 ft.

Method #3 – wind chokes around smaller toroidal cores and cram them into the backbox. I've done this with a different set of lighting fixtures, and it works a bit, but not well enough. There's significant noise reduction, but I still hear noise on high 20 meter antennas (I need about 10 dB more suppression), and on a Beverage that runs within about 50 ft of the noisy wiring (I need 12-18 dB more suppression). Which leads us to method #4.

Method #4 – use both the commercial filter and the smaller toroidal choke.

Method #5 – find and install a 12 power supply with good noise suppression.

Method #6 – replace the power supply with a real transformer. The main problem with this approach is that a suitably rated transformer won't fit in the ceiling backbox.

Wall Wart Power Supplies and Battery Chargers These products can be very nasty noise sources. Build either the commercial filter or the home brew choke into a steel electrical backbox, mounting multiple 2-gang outlets to the top of the box. Plug the noisy power supplies directly into the outlets. This minimizes the current path between the noise source and the filter. Long line cords plugged into these outlets may still need a toroidal choke (as close as practical to the equipment). And don't forget a multi-turn choke on the dc lead to the equipment.

Ferrite Chokes On a Service Drop Radiation of common mode noise from a typical residential overhead 240V power service can be suppressed by adding ferrite cores to the twisted triplet as it enters the premises. In Fig 31, six "big clamp-ons" (Fig 38) provided some suppression of noise on 40 and 30 meters to the antenna that ran parallel and fairly close to the power drop. This technique can only be used when the ferrite surrounds all three current-carrying conductors (two phases and the neutral), not just one of them. Thus, the ferrite sees only the common mode current, not the load current. The other cable visible in the photo is a telephone line, and chokes were applied to it at the point where it entered the house.

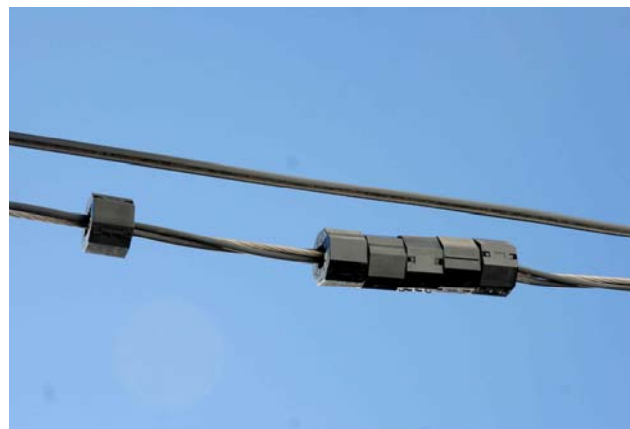

Fig 31 – Chokes on a Power Line (the bare conductor is the neutral, and is grounded)

Try Killing Power to Your House Many RFI specialists, including Mike Martin, K3RFI, recommend this as a first step in finding the sources of RF noise that you're hearing in your ham station. Always start by cleaning up your own house. In the process, you'll learn a lot of things to look for if

you have the need (and the opportunity) to eliminate noise in the homes of your neighbors. It's pretty easy to run a ham receiver from a 12V battery – indeed, all the radio gear in my ham shack (with the exception of the power amps) runs from a big 12V battery that is float charged by a regulated power supply. You'll be surprised by how much noise goes away when you kill the power to your own house. Then, while listening to your receiver, turn one circuit at a time back on at a time and track down the noise sources on that circuit using a process of elimination.

Chapter 6 – Baluns

So-called "baluns" are widely used in ham stations, but few hams understand how they work or what their real function is. Virtually all discussions of baluns begin by saying that a balun is used to connect balanced antennas to unbalanced transmission lines – it's like jazz coming up the river from New Orleans. While both statements contain a grain of truth, there's a lot more to both stories! This chapter is an attempt to fill that void.

In an ideal radio system, the transmission line for our antenna would act as if the transmitter (or receiver) was physically located at the feedpoint of the antenna, with nothing in between. There would be no loss, and no interaction of the feedline with the antenna. We've gotten to this point with microwave systems – indeed, all of the RF electronics for many of these systems can clamp onto the back of a dish and drive it directly. We're not there with HF (or even VHF) systems though, and not likely to get there, thanks to the power levels, wavelengths, and antenna types that are practical. So in the real world, we're stuck with transmission lines for most of our antennas. ***The primary function of most baluns, at least in our ham stations, is to minimize the interaction of our antennas with the transmission lines that connect them to our radios.*** So let's dive in and learn a bit more about how antennas, transmission lines, and baluns work.

Balance We should begin by defining a balanced circuit. ***A balanced circuit is not defined by the equality of current or voltage on the two conductors. Rather, a balanced circuit is one in which the impedances of the two conductors to the reference plane are equal in both magnitude and phase. A balanced circuit functions as a Wheatstone bridge, rejecting noise by virtue of the balance of the impedances within that system. [There is an excellent analysis of this in Whitlock, JAES, June 1995, and also on the [Jensen Transformer website](#).]***

Antennas and Balance We like to think of a center-fed dipole as a balanced antenna, and in an ideal world it would be. To achieve that, we would need to suspend it over perfectly flat and uniformly conducting earth, between electrically symmetrical support structures. There could be no buildings below it, no wiring, no conductive objects around it that were not perfectly symmetrical with the antenna, and the feedline would need to be perfectly perpendicular to the antenna all the way to the transmitter.

As hams, few of us are able to install anything approaching a balanced antenna. We must suspend them from metal towers, trees, or the side of building. Often the ground beneath them is not flat, there are power lines, telephone lines, and there is wiring in nearby buildings. The antenna has capacitive and inductive coupling to all conductive objects in its near field. Rarely will that coupling be symmetrical, and rarely will it be possible to quantify it. In short, even the best of our antennas are a compromise.

An example of a ham antenna that might have met that criteria of a balanced antenna was a dipole I was able to hang between two identical towers on top of the EE building at the University of Cincinnati when I was a student and trustee of W8YX in the early 60's. I used the word "might" because although the towers were mounted symmetrically on the building, one held a large beam antenna. There goes the balance!

Even with ideal ladder line feeding our real world "sort of" balanced antenna, the antenna imbalances cause the currents in the two halves of the antenna to be unbalanced (that is, unequal), so the current on two sides of our balanced feedline are not equal. The imbalance between the two currents is a common mode current, and it causes radiation from the feedline! And because all antennas work in reverse, any current flowing on the feedline couples unequally to the two sides of the antenna. The difference between those currents is sent back down the feedline as a differential signal to our receiver. That feedline current could be noise from our neighbor's battery

charger, or a station coming from a direction we thought our beam antenna was rejecting.

Coaxial Feedlines and Balance A coaxial feedline can add to the imbalance that already exists in our real world antenna. Because it is the most obvious of the imbalances (although not necessarily the dominant one) it is the one that we pay the most attention to. The way we pay attention to it is by adding a lump at the feedpoint that the guy at the ham radio store tells us is a balun. It's all nicely glued into a weatherproof housing that we can't take apart without destroying it, and the data sheet tells us nothing more than how wonderful it is. So now we're back where we started, asking "*What is a balun?*" And while we're at it, perhaps we should ask how it works.

Types of Baluns There are three fundamental types of baluns, and several variations within each type. The three types are very different electrically, and they interact differently with the imbalances of both the feedline and the antenna.

Voltage Baluns A "voltage" balun is essentially a transformer, most often with a primary and one or more secondary windings on a ferrite core. The Ruthroff baluns described by the late Jerry Sevick, W2FMI, and Doug DeMaw, W1FB, and the W2AU balun sold by Unadilla, are transformers (that is, "voltage" baluns) that use ferrites as a core to carry the flux between windings.

Transmission Line Balun A balun can also take the form of a half-wavelength of transmission line (Fig 32). In the most common configuration, the center conductor of a 50 ohm line is connected directly to one side of a 100 ohm antenna and also to a half-wavelength of the same line, which in turn drives the other half of the antenna. The two sides of the antenna are thus driven in parallel, but 180 degrees out of phase with each other (but only at the frequency for which the transformer (the extra length of line) is one-half wavelength. As we move away from that frequency, the phase shift will be a bit more or a bit less. The antenna still works, but the balance degrades a bit.



Fig 32 – A Half-Wave Balun

Current Baluns First published by Guanella and pioneered by Sevick, Joe Riesert (W1JR), and Walt Maxwell (W2DU), current baluns are actually common mode chokes applied to a feedline. Current baluns see only the common mode field. When wound with coax, this is true because all of the magnetic field associated with common mode current is outside the line, while all of the field associated with the transport of power from the transmitter to the antenna is inside the coax. When wound with parallel wires, the core sees the sum of flux from currents of opposite polarity; the differential components cancel, leaving only the common mode flux (due to the imbalance in the system). Current baluns work by adding a high impedance in series with the common mode impedance of the line, thus reducing the common mode current to a very small value – if no common mode current is allowed to flow on the transmission line, the current on the left half of the antenna must be equal to the current on the right half of the antenna, simply because there is no other path for current. There are three fundamental types of current baluns.

- ♦ **Solenoid Balun** The coaxial line is wound into a coil at the antenna. The choking impedance is the inductance of the coil. Reisert describes several designs for solenoid baluns (see Appendix 4), and the ARRL Handbook includes several designs for solenoid baluns.
- ♦ **Inductive Ferrite Choke Balun** The line is wound around a toroidal ferrite core that has low loss at the frequency where the balun is used, so all (or nearly all) of the impedance is inductive. The line may be coax or it may be bifilar (parallel wires). Reisert's toroidal baluns are wound on a material like #61 that has low losses at HF (Fig 12, Fig 33). [Reisert also introduced the concept of a crossover winding style, whereby half of the choke was wound in one direction around the toroid, then crossed 180 degrees to the other side of the toroid and wound in the opposing direction. Sevick noted that he was unable to measure any effect of this technique. My measurements confirm Sevick's results.]
- ♦ **Lossy Ferrite Choke Balun** Maxwell introduced the concept of passing a coaxial line

through a string of lossy ferrite cores to form a common mode choke, a design which has come to be known as the W2DU balun. Maxwell's design consists of 50 Fair-Rite 2673002402 beads, 0.19" long and just big enough to fit over RG-303 coax (Fig 34). One of his experimental models used 300 beads, and measured 4500 +j3800 ohms at 4 MHz. Notice that his choke is resonant at about 8.5 MHz because that is where his #73 beads are resonant. A W2DU balun will be most effective on 40M, 30M, and 20M.

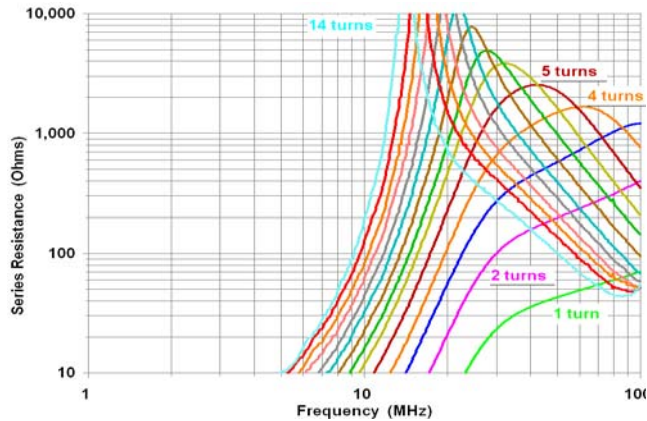

Fig 33 – R_s for chokes on 2.4" o.d. Fair-Rite #61

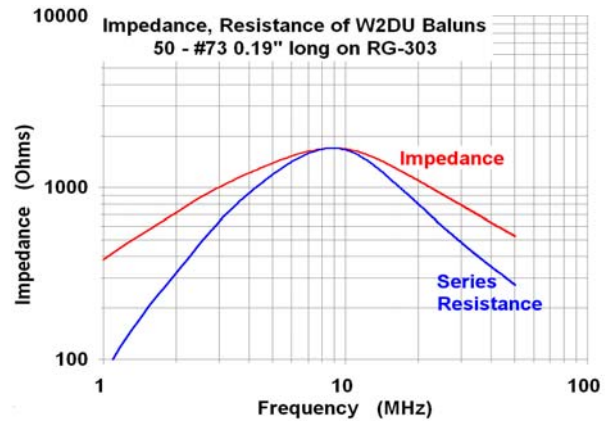

Fig 34 – A W2DU Balun (Measured Data)

Others have proposed variations of the W2DU balun without realizing the importance of resistance. Fig 35 is computed data for straight uncoiled "string of bead" choke baluns using 1.125" long #31 beads. As with all bead baluns, the impedance of a straight balun is approximately equal to the impedance of one bead multiplied by the number of beads in the string. The W0IYH balun uses 100 #43 beads, 0.562" long, 0.25" i.d. The resonance of these beads (and thus the balun) is around 150 MHz, so these baluns are strongly inductive on the HF bands! K3LR has measured them. His results suggest considerable stray capacitance, which in turn suggests either measurement error (stray capacitance is a common measurement error) or that his string of beads may be coiled (increasing stray C, lowering F_{RES} , and improving performance).

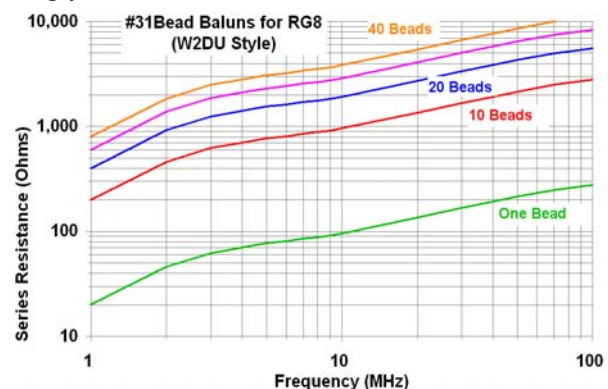
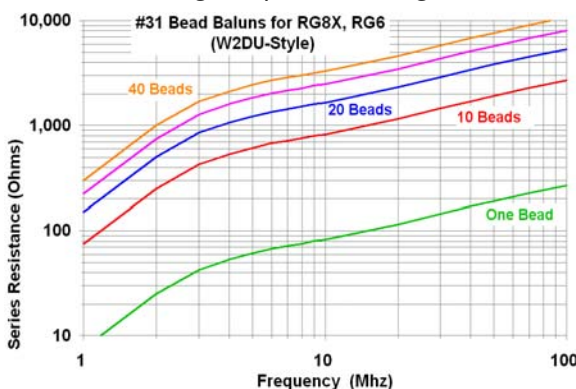

Fig 35 – Equivalent Series Resistance of #31 Bead Baluns (Computed from Fair-Rite Data)

Advantages of Current Baluns Maxwell seems to have been the first to realize that with a current balun, loss in the ferrite is not a bad thing if you have enough of it! (We'll discuss this in detail a little later). Maxwell, and Roy Lewallen (W7EL) showed that a current balun has some important advantages over a voltage balun, and that the advantages are so great that only current baluns should be used in most ham radio applications. [Walt Maxwell, "Some Aspects of the Balun Problem," QST March 1983, <http://w2du.com/r2ch21.pdf>] [Roy Lewallen, W7EL, "Baluns: What They Do and How They Do It," <http://www.eznec.com/Amateur/Articles/Baluns.pdf>] The ARRL Antenna Compendium Vol 1] Let's look at those advantages.

- ♦ Because the core sees only the common mode flux, a much smaller ferrite core is needed to handle high power without saturation.
- ♦ If the common mode impedance is high enough, common mode current can be forced to

near zero, which in turn forces near ideal balance.

Disadvantages of "String of Bead" Baluns The common mode (choking) impedance is the impedance of one bead multiplied by the number of beads. As a result,

- ♦ 1) We are stuck with the resonant frequency of the bead used in the string. If the bead is inductive, the choke will be inductive, and nearly all commonly available beads are inductive in the HF spectrum. The exception is Fair-Rite #73 (see Fig 34), and the largest cable that fits through the largest #73 bead is RG-303.
- ♦ 2) As Figs 34 and 35 show, it takes a very large number of beads to achieve even modest choking impedance. The usual compromise is using too few beads, which results in insufficient choking impedance. The resulting common mode current can overheat the balun, often to the point of failure, and couple RX noise.
- ♦ 3) This is a very inefficient use of the ferrite material.

Disadvantages of Voltage Baluns The ferrite core of a transformer balun (the Ruthroff "voltage balun") sees all of the transmitted power, so it is easily overheated and saturated by high power. Because voltage baluns are carrying the entire transmitted signal, they should not be allowed to saturate, because that would create both harmonic distortion and intermodulation distortion. You will be quite unpopular on the ham bands if you do either, and you will be quite likely to do so if you run high power through a voltage balun unless it is a very large one. ***This leads to the first two big negatives for voltage baluns – they must be large to handle power, and they can generate both harmonics and splatter if they are overloaded.***

Related to these negatives are two important design constraints – ***the cores of voltage baluns must have relatively low loss, and they need fairly high permeability to support the flux needed to carry the power. This limits them to a material like Fair-Rite #61 or #67.*** And yet another negative for voltage baluns – any loss component in the ferrite core reduces the quality of the balance that the balun is providing, and real ferrites have losses. ***The result is that voltage baluns don't do a very good job of providing balance either!***

When used in a transformer (voltage) balun, or in a choke wound with parallel wire line, a core with high losses (#31, #43, #73, #77, #78) will convert much of the transmitter power into heat. The result are 1) high losses (that is, several dB of the transmitter output is lost in the balun); 2) balun performance may degrade due to heating; 3) the balun may overheat; 4) the balun (or the line) may fail due to overheating (that is, the line may melt and either deform or short, the ferrite may crack).

Although voltage baluns are still sold and advocated in articles about ham building projects by authors who don't know any better, most authorities believe that they cause more problems than they solve, and should be avoided when there are other good options. This author strongly concurs. There is a far better way to transform impedances using ferrite cores. See ***Impedance Transformation with Current Chokes*** later in this chapter.

Lossy Toroidal Coaxial Chokes Winding multiple turns of a coaxial feedline through one or more lossy toroidal cores is simply another (and usually better) way to construct a W2DU balun. It is better because 1) ***it makes much more efficient use of the ferrite*** than a string of beads; and because 2) ***it is easy to achieve much higher choking impedances in a very practical form and at reasonable cost*** than with any other form of balun; and because 3) ***a high level of performance can be obtained over a wide frequency range with a single part.*** Conceptually, lossy toroidal coaxial chokes are no different from W2DU's original design, they have all of the advantages of other current baluns, and they can provide much better performance over greater bandwidth.

Disadvantages of the Reiser Toroidal Balun Because the design uses a low loss (high Q) material, the choke has a very high impedance only in the narrow range of frequencies to which it is tuned – roughly one-half octave. Below that range it is inductive with very low loss, and above that range it is capacitive, with loss that increases with frequency. It takes a lot of turns around a lot of cores to achieve acceptable performance on the lower HF bands, and a given choke is likely to be a good performer on only one ham band. Significantly better performance over a much wider frequency

range can be achieved with lossy toroids. This has major implications when the objective is reducing receive noise coupled from the transmission line to the antenna – the lossy toroid choke is capable of significantly more suppression and significantly greater bandwidth.

Advantages and Disadvantages of the Solenoid Balun The principle advantage of solenoid chokes is their simplicity. Losses and dissipation are inconsequential. Solenoid baluns (coiled up coax) must be relatively large if they are to provide even relatively moderately high choking impedance (typically 500 – 1,500 ohms), and are only practical on the upper HF bands.

Using Common Mode Chokes As Baluns Maxwell taught us to use a common mode choke at the feedpoint of an antenna to minimize interaction of the feedline with the antenna – that is, to decouple the feedline from the antenna. This choke ("current balun") works by inserting a high common mode impedance in series with the feedline, ideally as close to the feedpoint as possible. The obvious question is, how much impedance is enough? There are (at least) four criteria.

Dissipation The choking impedance must be high enough to reduce common mode current to the level such that the choke cannot overheat and damage the core or the coax.

Pattern Distortion We would like the choking impedance to be high enough so that feedline current does not distort the pattern of the antenna.

Noise Coupling The choking impedance should be high enough that any noise current that may be received on the feedline behaving as an antenna cannot flow onto the intentional antenna.

RFI Prevention The choking impedance should be high enough that the feedline does not radiate transmitter current near susceptible equipment in your home (or a neighbor's).

How Much is Enough? Traditionally, "choke baluns" have been built around the assumption that a choking impedance on the order of 500 Ω was enough. Maxwell considered 1,000 Ω sufficient to eliminate pattern distortion, and considered his bead balun design sufficient to handle maximum legal power, although others have debated that assertion. In a self-published applications note, Chuck Counselman, W1HIS, suggested that a choking impedance of 5,000 Ω as a more suitable target value to optimize noise suppression. My work and experience prove him correct.

The Dissipation Question is one of the most important, yet can be tricky to get a good handle on. For a simple common mode choke in a pure 50 ohm system, it's simple – worst case puts the full transmitter voltage across the choke under the condition of infinite imbalance, so the power is simply E^2/R . For a 1.5kW CW or SSB transmitter, the PEP voltage is 275 volts, but heat is produced by the average voltage, and the average voltage, even with heavy compression is at least 6dB less (one half, 138 volts). 275 volts (keydown) will burn 15 watts in a choke that is 5,000 ohms resistive, which is our design criteria. But once we start talking or sending CW, the average power drops by 6dB (one quarter) to less than 4 watts! Key-down modes like AM, FM, and RTTY will still burn 15 watts, but most transmitters and amplifiers must be de-rated by 2-3dB for key-down modes. If the duty cycle is 66% (continuous contest CQ'ing with few answers), we'd be hitting the choke with about 10 watts key-down and 2.5 watts for CW and SSB.

The analysis above is for a 50 ohm system. What if the choke is on the output side of an antenna tuner (for example, up in the air at the feedpoint, or somewhere along the line) and the tuner is stepping up the impedance to match a higher impedance load? An impedance step-up of 4:1 doubles the voltage, which increases dissipation by 6dB, so our worst case CW or SSB dissipation is back to 10 watts. Increase the impedance to 400 ohms and CW/SSB dissipation rises to 14 watts. And all of this analysis is for an antenna that very badly unbalanced!

Can a choke that provides 5,000 ohms choking impedance dissipate this much power? First, virtually heating shows up primarily in the conductor(s), not in the core. Any choke wound according to our 5,000 ohm design criteria can handle 4 watts, even in an enclosure with no air circulation. 15 watts is no problem if the choke is exposed to air, and may work in an enclosure. 60 watts (keydown modes, full legal power) is likely to overheat a single core choke, but unlikely to cause problems with a big multi-core choke. It all depends on the choke we use. As we'll learn later on, we'll need 5 turns of RG8 through five 2.4" o.d. #31 toroids to achieve 5,000 ohms R_S on 160, 80 meters, and 40 meters. We'll also learn about some bifilar chokes that can get us there.

Seven turns of RG8 will easily fit without a connector, four turns with a connector, so these are very practical chokes! Temperature rise is further minimized by leaving cores exposed to air flow (Fig 36 and 37). And remember, this is an extreme worst case set of operating conditions! [All cores look alike – the orange tape on these cores tells me these are mix #31.]



Fig 36 – Coaxial Chokes Wound to Minimize L and C



Fig 37 – A Bifilar Choke

How Chokes Fail *Common mode chokes subjected to high power fail when they are under-designed (that is, they have insufficient choking resistance), and when they are mistreated (that is, when they are in line with an antenna that is badly unbalanced and run at high power levels).* Using the analysis of Fig 36, it is easy to see how a choke that provides only 500 ohms choking impedance might easily overheat in this worst case condition.

Weight: A 2.4" o.d. #31 toroid weighs about 4 oz, and we need less than 8 ft of coax for five turns, so a five core choke on RG8 will add just about 4 lb to the weight of the antenna. The "Big Clamp-On" in Fig 5, data in Fig 39, can also be used for coaxial chokes; it weighs 11 oz, and is equivalent to three or four toroids. Can we use smaller coax? Probably, especially if our antennas are always reasonably well behaved. The failures mostly come when they are not. W8JI reports that he often feeds high dipoles for 160 and 80 with RG6 to reduce weight, thus reducing sag and the strain on support lines, and that a good RG6 will handle full legal power. My "workhorse" 160/80/40 dipole, fed with 150 ft of RG59B that I bought from "The Wireman" several years ago, worked fine with the full output of my Titan amp, even with a mismatch on the line that approached 2.5:1 during SSB contests. I've since replaced it with RG11 to reduce loss.

Choking Impedance and Noise Suppression Once we've satisfied the dissipation criteria, the ability of the common mode choke to suppress noise comes into play. The mechanism is simple. Any RF noise around your antenna will induce RF current on your feedline (and onto your antenna). When current flows on your antenna, you hear it in the receiver. The choke suppresses noise by adding a high resistance to common mode current between the feedline and your antenna, which in turn prevents it from showing up at the feedpoint and being sent back down the line to your receiver. For good noise suppression, the series choking impedance should be as high as possible. Again, 5,000 ohms is a good target value, and more could be better.

How Much Noise Reduction? Noise coupled from the feedline to the antenna will be reduced by $20 \log (I_2/I_1)$ dB, where I_2 and I_1 are the common mode noise current with and without the choke. Once you've added enough choking impedance that the common mode current is dominated by that impedance, the noise reduction is $20 \log (Z_1/Z_2)$ dB, where Z_2 and Z_1 are the common mode impedance with and without the choke. In other words, you get 6 dB of noise reduction for each halving of the current or doubling of the series impedance. This simple math explains why a 5K ohm choke is better than a 1K ohm choke!

Choking Impedance and RFI Prevention Again, a higher value of choking impedance is better. If the choking impedance is high enough to satisfy dissipation requirements, it's likely to be enough to prevent RFI in your home.

When should you use a "string of beads" choke, and when is a toroid choke better? The answer lies in factors like size, cost, and weight needed to achieve sufficient choking resistance. Both will work quite well – if enough core material and turns are used to provide enough choking imped-

ance. *A multi-turn choke on the right toroid is a far more efficient use of ferrite material, because impedance is multiplied by the square of the turns ratio, so a multi-turn toroidal choke is the clear winner below 30MHz. (See Table One in Chapter 7 for a cost and weight vs. benefits analysis.)*

When are "string of beads" chokes OK? Many rules are made to be broken. A few years ago, K3LR asked me if it was OK to form a W0IYH string of beads using clamp-ons on his 10M antennas, where the feedlines had been carefully phased for stacking, and modifying their length to add multi-turn chokes wasn't practical. Fig 35 shows that the answer is yes – if enough beads are used to provide sufficient resistance that even if the feedline resonates with their inductance, the resistance still kills the common mode current. Fig 35 also shows that a relatively small "string of beads" can be quite effective on 6M and 2M. Fig 35 is computed for beads that are 0.562 inches long. Roughly half that number of 1.125-inch beads will provide equivalent performance.

Temperature Characteristics At HF, especially below 25 MHz, the #31 material is a bit less subject to thermal runaway than #43 and #73 materials. (See Fig 25 and the associated discussion.)

Impedance Transformation with Current Chokes

Very good impedance transformation can be achieved by wiring good common mode chokes in series-parallel configurations. Examples are the high power "baluns" sold by DX Engineering to match 200 ohm, 300 ohm, and 450 ohm line to 50 ohm coax. The chokes are wired in parallel on the low impedance side and in series on the high impedance side. Fig 38 shows a 4:1 version of this design. The primary design considerations are that 1) the common mode impedance of each choke must be large enough that they do not short each other out or dissipate significant power; and 2) the common mode impedances of the chokes must reasonably matched each other. Two such chokes in series/parallel provides a 4:1 impedance transformation, three chokes provides a 9:1 transformation. The high power baluns manufactured by DX Engineering are Guanella "current" baluns.



Fig 38 – Current Choke (Guanella) Transformer

You can easily wind your own for a fraction of the cost following my guidelines for coaxial chokes on #31 or #43 cores, or with bifilar windings on those cores using the measured data in Appendix One as a guide. Putting them in an box, however, is not so easy. There will be stray capacitance between the chokes, and between the chokes and a conductive enclosure. With a non-conductive enclosure, there can be capacitance to metal around the enclosure. This capacitance adds to what is already there, so it can detune the chokes, lowering their resonant frequencies, and it can degrade system balance. In other words, building 1:4 and 1:9 chokes isn't as easy as it looks.

Dissipation W8JL, designer of the DX Engineering baluns, notes that connecting either terminal (or even a center tap) of the high impedance side to ground can cause the entire transmitter voltage to appear across one of the chokes. Tom's analysis is solid to the extent that it describes "worst case" conditions, but it misses the fact that the so-called "grounds" are usually thousands of ohms apart. It also assumes key-down conditions. But he is entirely correct that if you're going to ground one high impedance terminal of a 4:1 or 9:1 choke balun at the balun, you'll need a very high value of choking impedance to avoid dissipation problems when transmitting key-down modes at 1.5kW.

The same dissipation analysis we used for the simple common mode choke (page 28) applies to a choke that is part of a 1:4 current balun used according to its design criteria – connecting a 50 ohm source and a 200 ohm load, and with neither conductor of the 200 ohm side grounded. Sevick analyzes this choke with no ground on the 200 ohm side, and assumes half of the output voltage is across each choke. W8JL assumes a zero-impedance grounded center-tap, which places the full transmitter voltage across one choke, but no voltage across the other. The real world is somewhere between these two simplistic analyses, and every system will be different. What if the choke is used at the output of an antenna tuner that steps up the impedance to match 400 ohms? That worst case math increases the voltage by 3dB, which increases the dissipation in the choke by 3dB, so we have 7.5 watts in the choke for CW or SSB, 30 watts for AM, RTTY, or FM. In a 9:1

choke, worst case dissipation in any one choke can be 3-6dB greater (that is, double or 4 times).

In W8JI's worst case analysis of a 1:4 choke with one secondary terminal having a zero impedance short to the primary, he shows that one choke can have the full transmitter voltage while the other has either double the transmitter voltage or zero volts across it. Sevick's analysis places the transmitter voltage across each choke. Thus, in an unventilated enclosure, the worst case dissipation in the box is for 2X the transmitted voltage in one choke.

The Biggest Clamp-On Fig 39 is data for coils wound through the "biggest Fair-Rite #31 clamp-on" in Fig 5. Measured data for 1-5 turns through this part and a somewhat smaller one are shown in Fig 39. The heavier lines are the biggest clamp-on (1" i.d.); the lighter lines are for a 0.75" i.d. part. While the smaller part provides a bit higher impedance at low frequencies, it is far less useful because it doesn't allow as many turns of most cables on which we would like to use it. This big clamp-on is quite useful in many applications where it isn't practical to remove a large connector. Although we only measured small wire chokes up to five turns with this part, it can certainly be used with more than 5 turns of some cables. More turns moves the resonance even further down in frequency; it also increases the equivalent series resistance below resonance, -and for up to about one-half octave above resonance. See Fig 45 for coaxial chokes using the "biggest clamp-on."

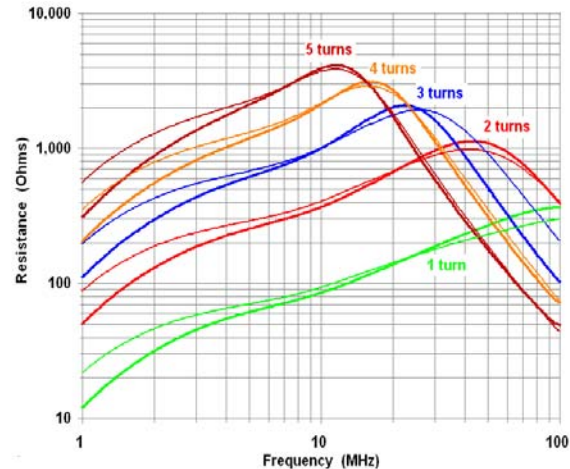

Fig 39 – The "Biggest #31 Clamp-On" (Fair-Rite 0431177081)

Chokes Wound with Coax Up to this point, all of our measured data has been for small diameter wire wound around the core. The stray capacitance is a combination of the capacitance between the turns and the dielectric (the ferrite core) and the capacitance between the turns. The coaxial chokes of Fig 36 will have more stray capacitance than these smaller chokes or a bifilar choke like Fig 37), and they will have more inductance (by virtue of their greater length), but the loss component, mostly contributed by the ferrite, will be about the same as for the smaller chokes.



Fig 40a – Measuring Coaxial Chokes

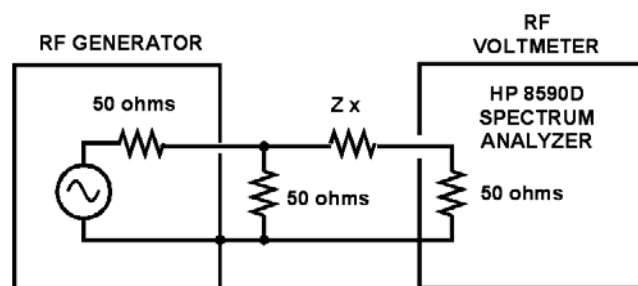

Fig 40b – Equivalent circuit

Fig 40a shows the test setup, and Fig 40b shows the equivalent circuit. Since the HP generator is designed to work into a 50 ohm termination and calibrated for that load, a 50 ohm "through" termination was added at the output of the generator. Without this termination, the generator voltage would be about 6 dB greater. (and the elec-

tronic attenuator might not work as well). The unknown impedance can then be computed from the voltage divider equation. For all values of unknown Z greater than 500 Ω, the error is less than 10%, and less than 5% for unknowns greater than 1,000 Ω. I measured the stray capacitance of this fixture as 0.4 pF at the terminals connected to the unknown impedance.

This is a very useful measurement setup, and can achieve reasonable accuracy for rather high values of impedance. K6MHE sent me a 13-turn choke he had wound on three #61 cores. I was able to measure an impedance greater than 150K ohms at resonance (15.5 MHz). The spectrum analyzer could be replaced by an RF voltmeter or scope, in parallel with a suitable load resistor.

How Much Stray Capacitance Is There? This is important, because it moves the resonance, and thus the frequency range over which the choke is effective, down quite a lot. To answer this question, I wound a lot of coax chokes (in the winding style of Fig 36) and measured them. Accurately measuring impedances in the range of 1K – 10K at HF is not easy, especially with Network Analyzers and Antenna Analyzers that make reflection-based measurements. Because the unknown impedances being measured are so far from the center of Smith Chart, very small values of stray reactance cause very large measurement errors. It is far more accurate to measure the unknown impedance (the choke) as the series arm of a voltage divider. I don't have access to a suitable Vector Network Analyzer (VNA), but I do own an HP 8657A RF generator and an HP 8590D Spectrum Analyzer. The 8590D includes a calibrated voltmeter that reads the voltage across a calibrated 50 ohm termination. Doing some math gives me the magnitude of the impedance. And since we already know that the choke is essentially a parallel resonant circuit, we can learn most of what we need to know about it by studying its Q and the values of Z far above and below resonance.

More Measurements: Fig 41 displays data obtained in this manner for RG8 chokes wound on stacks of #31 3.4" o.d. cores, in the style of Fig 36. Note that the resonant frequency falls both with more turns and with more cores in the stack. This is to be expected – in addition to the resistive impedance we are looking for, each core also adds inductance and capacitance, both of which lower the resonant frequency. Our goal is 5K ohms over a broad frequency range (at least three ham bands). Fig 40 shows very good options for 1.8-14 MHz, but makes it clear that it isn't easy to get more than about 3K at 30 MHz in a single choke, and it will be difficult to wind a single choke that covers 14-30 MHz (for use on a multiband antenna). Note that the "bubbles" around 20 MHz are measurement errors resulting from artifacts of the active attenuator in my HP 8657A, and not characteristic of the actual choke.

Curve Fitting to Find R, L, and C values: Fig 42 is the impedance of a simple parallel resonant circuit consisting of a 320 μH inductance, a 4 pF capacitance, and a 6,600 ohm resistance. Fig 42 is simply a plot (using Quattro Pro) of the equation for the impedance of a parallel resonant circuit consisting of those component values. The values were selected so that the curve closely approximates the 5 turn choke wound on 7 cores in the vicinity of resonance – the red curve in Fig 41. This circuit has a Q of 0.73 at resonance. Note that as we move away from resonance by more than about 2 octaves (a 4:1 frequency change), the calculated curve increasingly deviates from the measured data. This should come as no surprise, since the permeability and the permittivity of the ferrite material vary with frequency.

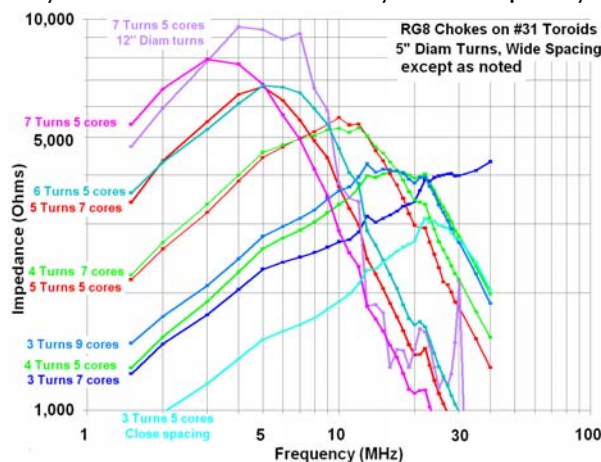

Fig 41 – Measured Impedance of RG8 Chokes wound on stacks of #31 2.4" toroids

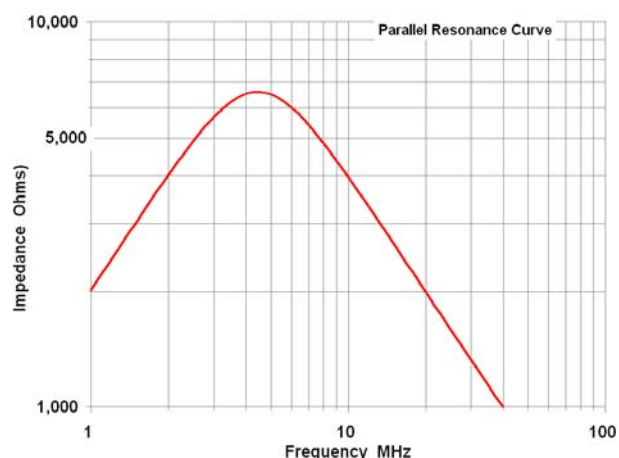

Fig 42 – Impedance of a parallel resonant circuit of 320 uh, 4 pF, and 6,600 ohms

Note that for this particular choke, 4 pF is the total parallel capacitance around 4.5 MHz – the ca-

capacitance between the coax and the ferrite, plus the capacitance between the turns of the coax that is close together within the cores, plus the capacitance between the turns of the coax that are widely spaced outside the ferrite cores, plus the 0.4 pF capacitance of our test fixture. How about the capacitance at 30 MHz? If we assume that the inductive reactance has dropped by a factor of about 8 and the capacitive reactance has increased by the same ratio, the capacitance at 30 MHz is approximately equal to $1/(2\pi f Z)$, or about 5.3 pF.

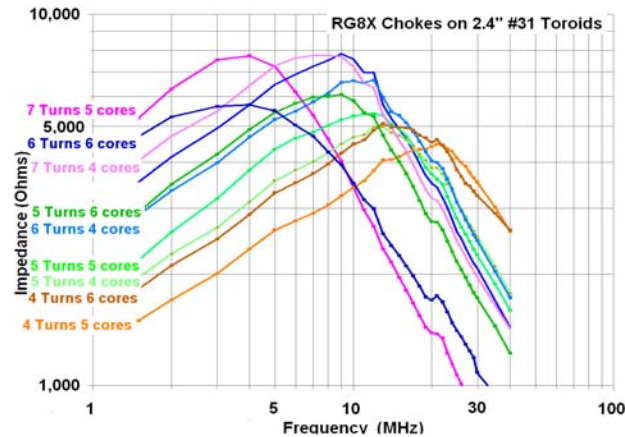

Fig 43 – Measured Impedance of RG8X Chokes wound on stacks of #31 2.4" toroids

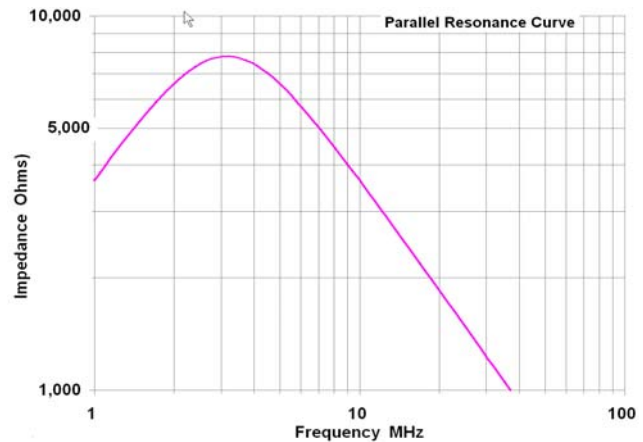

Fig 44 – Impedance of a parallel resonant circuit of 590 uH, 4.3 pF, and 7,800 ohms

Fig 43 shows data for chokes wound using RG8X, and Fig 44 is a simple parallel resonant circuit that approximates a 7 turn choke wound around 5 cores (the magenta curve in Fig 42). The capacitance value is a bit higher, and the Q is a bit lower. Applying the same techniques to the 4-turn 5-core RG8X choke of Fig 43 (the orange curve) yields circuit values of 56 uH, 1.3pF, 4,400 ohms, and a Q of 0.67.

How good are these circuit values? Certainly they are a first approximation, based on an approximate equivalent circuit. I would trust them to about 25% – there easily might be enough stray L and C in the test setup to contribute that much error. And remember, L, R, and C contributed by the ferrites all vary because the complex permeability and the permittivity of the ferrites vary with frequency. So the answer to our question, "How much capacitance is there?" is, "typically between about 1 pF for a small choke and about 7 pF for a larger one with a lot of turns." The other part of the answer is, we can control that capacitance and keep it small enough that our chokes work by paying reasonable attention to winding style.

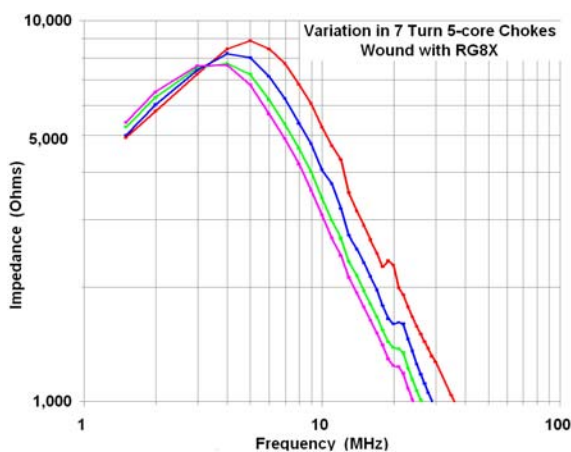

Fig 45 – Variation of chokes with winding style, coax outer jacket material

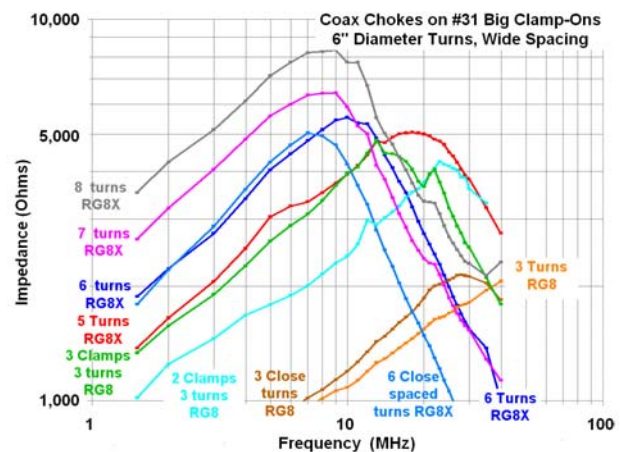

Fig 46 – Measured Impedance of Chokes wound on the "Big #31 Clamp-on"

Your Mileage Will Vary Fig 45 shows the variation in impedance that can occur based on the details of how the choke is wound, and on the jacket material. The magenta curve is for a choke

whose turns are tightly bunched together both inside and outside the toroids. Both the stray capacitance and the inductance of the coax are maximized (for a given number of turns and winding diameter). The other three curves are for chokes whose turns are intentionally spread wide apart outside the toroids. One of them uses somewhat larger diameter turns and a different type of RG8X. Capacitance is a function of spacing, geometry, and the dielectric material. The diameter of the shield, as well as the thickness and permittivity of the jacket material all can cause variations in the capacitance. In all of the measurements, I saw the greatest unintentional variation from one to another with chokes having a lot of turns of RG8X, and the least with those wound using RG8.

Tolerances in the Ferrites Fair-Rite #31 cores are considered suppression components, and because in the world of suppression, more impedance is considered better, their performance specifications are typical minimum values of impedance over a range of frequency. That's fine for our purposes, but don't expect exact agreement from one part or batch to another.

Chokes and Modeling A wire can be added to an NEC model for a dipole (or other antenna) to analyze the contribution of common mode current on the coax shield to antenna performance – simply connect a wire from one side of the feedpoint to ground. Beginning with version 4 of W7EL's excellent EZNEC+, we can add a network, including a parallel RLC network, to any of the wires in the model. Use the values of R, L, and C that are determined empirically (see Figs 41 and 43, and the associated discussion). We might also add a nearby feedline that we suspect might need an "egg insulator" choke, and study the results with and without the choke.

The Biggest Clamp-On Fig 46 is measured data for various coaxial chokes wound through the "biggest #31 clamp-on" of Fig 5 and Fig 39. This is a very useful and versatile part, because it can easily be applied to cables without removing a large connector, or without disconnecting them from an existing system.

Chokes in Series As we learned earlier, the impedances of multiple chokes in series will add, taking the reactances of each choke into account. That is, if one choke looks inductive and resistive at a given frequency and the other choke looks resistive and capacitive, the resistances will add, but the capacitance and inductance will cancel (at least partially).

Fig 47 is measured data for three combinations that are potentially useful for multiband antennas.

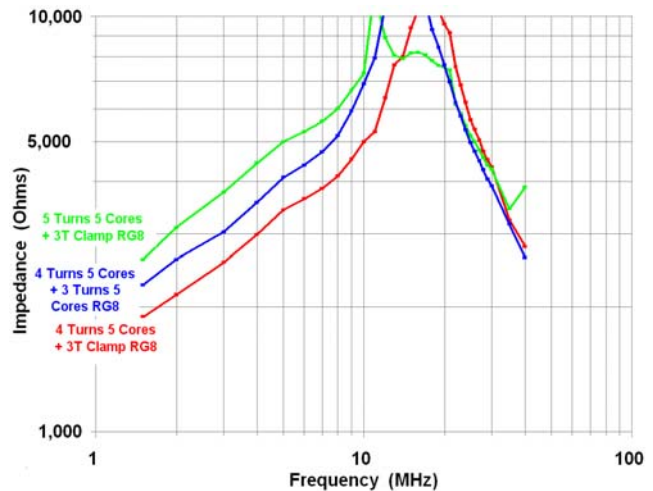

Fig 47 – Impedance of Chokes in Series

Bifilar Ferrite Chokes can be as effective as coaxial chokes in blocking common mode current, and a good small choke can handle 1.5kW. To prevent excessive dissipation in the choke, the bifilar winding must have very good symmetry and the 5,000 Ω impedance guideline must be observed.

Effect of Wire Insulation Fig 48 shows that the wire insulation shifts the resonant frequency. The increased overall diameter also reduces the maximum number of turns that can be wound on any given core. Sixteen turns appears to be the practical limit for #14 THHN without overlapping turns.

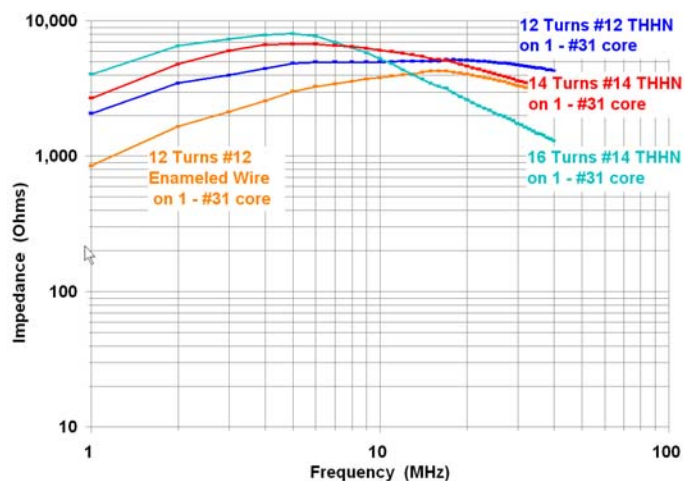

Fig 48 – Some Useful Bifilar Chokes

Bifilar Chokes and Transmission Loss A bifilar choke wound around a toroid forms a short transmission line whose impedance may be different from that of the line into which it is inserted. Thus, a bifilar choke can introduce some mismatch. A tightly spaced enameled #14 bifilar winding is very close to 50 ohms. Tightly spaced #14 THHN windings are close to 100 ohms. Not including mismatch, copper loss in a bifilar choke is quite small – for #14 wire, less than 0.01 dB at 3.5 MHz and 0.03dB at 28 MHz. Any additional loss due to mismatch is unlikely to exceed 0.2dB, and will be distributed over the entire length of the line.

Coaxial Chokes and Transmission Loss Coaxial chokes do not introduce any mismatch, so the loss of a coaxial choke is simply the loss for the additional length of coax required to wind it. At 2 ft/turn, chokes wound following Cookbook guidelines should add no more than about 0.05 dB loss if wound with low loss RG8; and no more than about 0.15 dB if wound with a low loss RG8X.

A Common-Mode Choke as an "Egg Insulator" Have you ever noticed the egg insulators in the guy wires for an AM broadcast tower? Their function is to prevent the guy wires from interacting with the antenna. The egg insulators break the guy lines into small enough pieces that each is a small fraction of a wavelength at the operating frequency. Often, one or more *feedlines* in a typical ham station may interact with another antenna. The result of this interaction is unpredictable at best; there's a good chance that the result will degrade antenna performance. Seasoned antenna engineers know that any near-resonant object within several wavelengths of an antenna can interact with it. We also know that most interaction is multiplied by the cosine of the angle between the wires. This means that interaction is likely to be greater for wires that run in parallel with each other, and far less likely if they are at 90 degrees to each other.

Here's an example from my own station. A few years ago, I installed a top-loaded vertical (with a good radial system) that was working quite well on 80 and 160 meters. A month or two later, I added a fan dipole for 20, 15, and 10 meters at about 100 ft. Most of the 150 ft-long feedline for the fan is vertical, rising about 90 ft from the vertical antenna, and it runs right past the vertical's feedpoint to get to the shack. I noticed that the vertical wasn't working at all on 80, and wasn't working nearly as well as it originally did on 160. On a hunch, I added a common mode choke at the transmitter end of the feedline for the fan dipole and the 80/160 vertical started working again!

Chapter 7 – K9YC's Choke Cookbook

Armed with the measured data in Figs 41-47, I have updated my guidelines for chokes wound with coax. All of these chokes should be wound to minimize their stray capacitance and inductance, by using the smallest diameter turns that don't degrade the coax due to excessive bending, and by maintaining as much separation between turns as practical outside the stack of cores. See Fig 36.

Transmitting Chokes These criteria provide superior suppression of receive noise and excellent freedom from pattern distortion. They are conservatively rated for full legal transmitter power into antennas that are reasonably well balanced. These chokes are 2-8 times better than the best commercial chokes. If receive noise is not part of your criteria, and if you're not running maximum legal power, fewer cores may be used. Most recommendations are for the minimum number of cores that achieve the 5,000 ohm criteria. Where practical, I've included options for 4 turns of RG8 in 2.4" o.d. cores (so they can be wound without removing the connector).

Counting Turns: The number of turns is the number of times the coax passes through the cores. *For chokes wound in the style of Fig 36, this is one more than the number of turns external to the cores.* For example, a five turn coax choke would have only four turns outside the toroids. The chokes in Fig 36, looking from left to right, have four, five, and seven turns.

160 and 80 Meters:

- ♦ With RG8 or RG11, use 7 turns through five 2.4" o.d. #31 toroidal cores.
- ♦ With RG-6, RG-8X, and RG-59, use 7 turns through five 2.4" o.d. #31 toroidal cores.
- ♦ With RG-6, RG-8X, and RG-59, use 8 turns through a Big #31 Clamp-On

80, 40 Meters:

- ◆ With RG8 or RG11, use 6 turns through five 2.4" o.d. #31 toroidal cores, or 5 turns through 7 #31 cores.
- ◆ With RG-6, RG-8X, and RG-59, use 8 turns through a Big #31 Clamp-On or 7 turns through four 2.4" o.d. #31 toroidal cores.

30 Meters:

- ◆ With RG8 or RG11, use 5 turns through five 2.4" o.d. #31 or #43 toroidal cores.
- ◆ With RG6, RG8X, or RG59, use 8 turns through a Big #31 Clamp-On or 6 turns through four 2.4" o.d. #31 or #43 toroidal cores, or 5 turns through 5 cores.

20 Meters Monoband:

- ◆ With RG8 or RG11, use 5 turns through four 2.4" o.d. #31 or #43 toroidal cores, or 4 turns through 6 or 7 cores.
- ◆ With RG-6, RG-8X, and RG-59, use 5 or 6 turns through a Big #31 Clamp-On, or 8 turns through two 2.4" o.d. #31 or #43 toroidal cores or 7 turns through 3 cores.

15 Meters Monoband:

- ◆ With RG8 or RG11, use 4 turns through five 2.4" o.d. #31 or #43 toroidal cores, or 4 turns through six cores.
- ◆ With RG-6, RG-8X, and RG-59, use 5 turns through a Big #31 Clamp-On, or 4 turns through five 2.4" o.d. #31 toroidal cores.

10 Meters Monoband:

- ◆ With RG8 or RG11, use 3 turns through seven 2.4" o.d. #31 or #43 toroidal cores, or 4 turns through 5 cores.
- ◆ With RG-6, RG-8X, and RG-59, use 5 turns through a Big #31 Clamp-On, or 4 turns through five 2.4" o.d. #31 or #43 toroidal cores.
- ◆ For a traditional W2DU "string of beads" choke, use 20 of the 1.125" long cylinders listed in Appendix One.

Multiband Antennas for 20-10 Meters, 30-10 Meters, and 40-10 Meters:

- ◆ With RG8 or RG11, use two chokes in series, one with four turns on 5 cores and the other with three turns on 5 cores.

Multiband Antennas for 20-10 Meters:

- ◆ With RG6, RG8X, or RG59, use 5 turns through a Big #31 clamp-on or 4 turns through six 2.4" o.d. #31 or #43 toroidal cores.
- ◆ To use the Big Clamp-Ons with RG8 or RG11, use three 3-turn chokes in series, each with a single clamp-on. Wind only these clamp-on chokes with their turns tightly coupled.
- ◆ For a traditional W2DU "string of beads" choke, use 40 of the 1.125" long cylinders listed in Appendix One.

6 Meters:

- ◆ With RG8X, use six 2-turn chokes wound on the RG8 cylinders or clamp-ons in Appendix 1.
- ◆ With RG8 or RG8X, use 3 turns through 7 cores, two 3-turn chokes, each wound on a Big #31 clamp-on, or a string of at least a dozen of the clamp-ons or cylinders in Appendix 1.

Coax Chokes for 100 watts or less: Use RG58 and follow the winding guidelines for bifilar chokes.

Compact Chokes for 1kW: Use RG303 and follow the winding guidelines for bifilar chokes.

Chokes in Enclosures Placing any choke in a close-fitting, conductive enclosure is likely to increase the stray capacitance and lower its resonant frequency. These guidelines are for chokes that are not in conductive enclosures. Enclosures inhibit air flow, so may get warm with high power.

Bifilar Chokes Use #14 THHN (house wire) for up to 1.5kW; #16 is sufficient for up to 800 watts. Use the winding guidelines below for 2.4-inch o.d. toroidal cores. Allow 2.5 inches per turn plus 5 inches for connections at each end. Use tape or ty-wraps to form the two conductors into parallel wires. Cut off any excess after winding.

Frequency Range	Bifilar Choke (See Fig 37, Fig 48)
1.8 – 5 MHz	16 bifilar turns of #14 THHN on one #31 core
3.5 – 10 MHz	14 bifilar turns of #14 THHN on one #31 core
10-30 MHz	12 bifilar turns of #14 THHN on one #31 or #43 core

Important Note: Do not cut corners winding bifilar chokes if you will be running high power. The primary cause of choke failure is insufficient choking impedance.

General Suppression Chokes (not on transmitting lines): Use the graphs of measured data to tell you the number of turns needed on a single core for 5K ohms equivalent series resistance at the frequency of the interference.

Receiving Antennas benefit significantly from the addition of a common mode choke to isolate the antenna from its feedline. Both ends of the RG6 feedline to each of my Beverages takes 8 turns through one of the Big Clamp-Ons.

"Egg Insulators:" Use chokes as "egg insulators" on a feedline that is longer than about $\lambda/4$ at the frequency of an antenna that it could interfere with. Use the chokes recommended for the frequency of the antenna that you suspect might be interfered with. Use enough chokes that the longest piece of un-choked line is less than about $\lambda/4$. Chokes are most important on lines that are approximately in parallel with the antenna in question.

Example: A feedline is running where it might be interfering with an 80 meter vertical. Try to break it down into pieces that are no longer than $80/4$ meters (about 67 ft).

Table One summarizes cost and weight considerations for various chokes and construction methods. Traditional "string of beads" chokes are more expensive and heavier for equivalent performance. Cost and weight includes for the added length of coax for the choke. Weight can also be reduced by using specialized coax like RG303, rated for high temperature and high voltage. Costs assume group purchase in large quantities by a ham club.

Table One – Weight and Cost of Ferrite Parts and Complete Chokes

Ferrite Part, Chokes	Weight (oz)	Cost	Notes
1" Long RG8 Cylinder	2	\$1.50	For "string of beads" chokes
1" Long RG8X Cylinder	.55	\$0.90	For "string of beads" chokes
2.4" o.d. #31 Toroid	4	\$3.50	
Big Clamp-On	11.5	\$12	
RG8 per turn	2.1	\$1	
40 RG8 Beads	80	\$120	Multiband 20-10
40 RG8X Beads	22	\$36	Multiband 20-10
Choke - 5 turns RG8 5 cores	30	\$24	20M, 15M
Choke - 7 turns RG8 5 cores	36	\$26	160M – 40M
Choke - 7 turns RG8X, Big clamp	15	\$15	160 – 40M
Choke – 7 turns RG8X 5 cores	24	\$24	160 – 40M
Bifilar choke – 14 turns #12	6	\$5	160 – 30M

The Big Clamp-Ons appear to be expensive but they're not – one is roughly equivalent to three or toroids! They are wonderful for portable and Field Day operations, because you can easily apply them to coax without taking the connector off. There is another advantage – chokes for 160-40 meters using the Clamp-On weigh about a half pound less than one using toroidal cores.

Shunting Common Mode RF to Earth Earth connections are almost never a solution to RFI problems, but there is one important exception. We know that RF induced by antenna action on cables entering or leaving equipment is coupled into the equipment by pin 1 problems, and by poor common mode filtering on balanced circuits. We can attack this kind of RFI by *diverting* that current away from the victim equipment. We do this by giving it connection to the shielding enclosure of the interference source, or to the shielding enclosure of the victim equipment, or to the earth.

This technique can be used to suppress RF picked up on the coax feeding Beverage antennas. Drive two ground rods at the feedpoint, one to terminate the Beverage and the other several feet away. Make a coax jumper cable long enough to reach between the Beverage and the second ground rod with enough turns for that 8-turn choke. Connect the coax shield both at the Beverage and at the second ground stake. Add a second 5,000 ohm choke on the shack side of the stake.

To use this technique on telephone lines, which are balanced, you'll need equal value capacitors from each side of the line to the ground rod. Use only enough capacitance to shunt the RF – the caps are in series across the line, and too much capacitance will kill or degrade a DSL signal. You'll also need the chokes.

Chapter 8 – Solving Problems in the Shack

K9YC's Serial Cable Most rig control (Kenwood, Yaseu, and Elecraft) uses only a straight-through connection of the Receive Data (RD), Transmit Data (TD), and signal return lines (pins 2, 3, and 5 in a DB9). In addition, popular contesting software can be set up to use the DTR line (pin 4) to send CW and CTS (pin 7) for PTT. The K9YC serial cable uses CAT5 (or CAT6/7) cable. One pair is used for RD, one for TD, one for DTR, and one for CTS. The solid color of each pair goes to the signal pin, the striped color of each pair goes to the shell of the DB9. Using twisted pair greatly improves RF rejection, using multiple conductors for signal return minimizes IR drop coupling of hum, buzz, and noise, and using the DB9 shell puts a band-aid on pin 1 problems in the equipment on either end.

There are several possible ways to implement the keying and PTT interface. You can, for example, put all four lines in a single CAT5/6/7 cable, with a breakout at the radio. This usually results in an interface that is tied to a particular radio. You can also make a generic cable that carries only the RD and TD signals, then add a DB9 female-male "barrel" at the computer that carries through RD and TD while breaking out DTR and CTS for keying and PTT to short lengths of small coax with a copper braid shield. I've done both of these, and they both work fine.

Plain, ordinary, unshielded CAT5/6/7 works fine for the vast majority of ham shacks. If you are running high power at 20 MHz or above to an antenna that is closer than about 10-20 ft from the serial cable, shielded twisted pair cable may be needed. You could use shielded CAT5/6/7 (if you can find it), but good balanced audio cable with a braid shield works well too (for example, Belden 1901A, 1902A, etc.). In this application, use one pair per circuit, but connect the signal returns for each pair to pin 5 at each end, and use the shell of the DB9 for the shield(s).

I developed the K9YC Serial Cable to solve an extreme "RF in the shack" condition at my old QTH in Chicago. The fact that it worked there proved how "bulletproof" a solution it can be. To work 160 and 80 on my very small city lot, I tied together both sides of the twinlead feeding my 80/40 dipole and loaded it against a "ground" system that consisted of a wrought iron fence and a few short radials. The feedline (in this case, a radiating part of the antenna) ran within 2 ft of the serial cable. With the original Elecraft serial cable (parallel wires, shielded) the computer line driver locked up at just over 10 watts; with the unshielded K9YC cable, I could run that antenna at legal power on any band below 15 meters! On 15 meters and above, I needed the shielded version to hit full power. *[I didn't use this improvised antenna above 80 meters – it wasn't at all effective on the higher bands. I loaded it that way only to test the effectiveness of the serial interface.]*

Why was shielding needed on the higher bands but not needed on the lower bands? Simple. The antenna was at a current maxima in the shack and the wiring was so close that it was in the near field (less than $\lambda/6$), so coupling was primarily magnetic. On the highest bands, the wiring was at greater spacing as a fraction of a wavelength, so the electric field was beginning to be significant.

As we learned earlier, cable shields provide only electric field shielding, while twisting pairs strongly rejects magnetic fields. See Chapter 1 for a discussion of these fundamentals, and Chapter 9 for an introductory discussion of fields.

Unbalanced Audio Interfaces Because virtually all ham gear and all computer and/or audio equipment we connect to our ham gear is *unbalanced*, we're stuck with *unbalanced wiring*. In our discussion of the fundamentals, we learned that shield resistance couples power-related hum, buzz, and noise into unbalanced wiring as a result of IR drop on the shield. We also learned that nearly all of this gear has pin 1 problems. And we learned that *at power and audio frequencies*, the IR drop is minimized by four simple measures, and that their beneficial effects are additive.

- ♦ Minimize the resistance by using cables with a *beefy copper braid shield*. Avoid hi-fi patch cables, which tend to have flimsy, high resistance shields. (-6 dB/halving of resistance)
- ♦ Minimize the resistance by keeping the cables as *short* as practical. (This has the added benefit of minimizing the behavior of the cable as an antenna, which in turn minimizes RF coupled by a pin 1 problem where the cable terminates). (-6 dB per halving of length)
- ♦ Minimize the hum/buzz/noise voltage that causes the current by plugging all of the interconnected equipment into the *same AC outlet*, or if that is not possible, into outlets with a *very short connection between their green wires* (adjacent outlets). When using different outlets, bond the backboxes together with short lengths of heavy copper braid. (This also minimizes hum/buzz coupled by pin 1 problems).
- ♦ Bond the enclosures of interconnected equipment together with short lengths of heavy copper braid. This diverts most of the hum/buzz current that would otherwise flow on the cable shield to the lower resistance braid. You don't need to buy braid – simply strip the outer jacket from a junk length of RG8 or RG11 that has a heavy copper braid shield. The braid of a good transmitting coax like Belden 8213, 8214, 8237 is equivalent to #10 copper, which is nearly 30 dB better than the flimsy shields typical of most hi-fi cables.

Audio Transformers One common solution to the hum/buzz part of the problem is to add audio transformers to each interconnection, thus breaking the path for low frequency current. Simple audio transformers block audio frequency current, but the capacitance between their windings lets RF couple across the transformer as if weren't there. To block RF, the transformer must include dual Faraday shields. [A Faraday shield is a conductor placed between windings; when that conductor is grounded, it shorts RF to ground rather than coupling it between windings.]

A cheap transformer can cause more problems than it solves. Most power supplies in our ham shacks include large power transformers that produce strong audio frequency magnetic fields around them. Transformers must be surrounded by mu-metal to shield them from these magnetic fields – otherwise, strong 60 Hz hum (50 Hz in some countries) will be coupled into them!

Transformers built with both of these shields aren't cheap. Good ones are made by Jensen Transformers, <http://www.jensentransformers.com> and Lundahl Transformers, <http://www.lundahl.se>

The good news is that you don't need a transformer (or an expensive USB or fiber interface) if you follow my guidelines for Unbalanced Audio Interfaces and use the K9YC Serial Cable for rig control! You only need one of these boxes if you need the SO2R switching, interfacing, and control they provide.

Feeding Computer Audio To Your Radio If you want to know why this works, study the preceding material and Appendix 5 on Audio Levels. Do all of the following:

- ♦ Plug all of the interconnected equipment into the same power outlet or to outlets in the same backbox, and bond together all of the interconnected equipment with heavy copper braid, as described above.
- ♦ Make up a cable that connects one channel of your sound card output to the audio input of your radio. Pay careful attention to the guidelines above for *Unbalanced Audio Interfaces*.

- ♦ If the radio input is at mic level, add a simple resistive voltage divider inside the connector that plugs into the radio. Use a 4.7K resistor in series with the audio, and connect a 470 ohm resistor between the mic input and mic ground. If you're using a line level or "patch" input to the radio, make the series resistor 1K. This prevents the computer from overloading the radio's input stage and causing distortion.
- ♦ Carry the shield connections straight through from computer to ham rig.
- ♦ Look for a setting in the control software for your sound card that sets Playback levels for your sound card. On a Windows PC, the setup screen can be accessed by clicking on the speaker icon on the taskbar, then selecting Options, and then Playback. You should see a screen with volume controls for various computer signals that can be sent out of the sound card on the 1/8-inch jack. RTTY, PSK, and SSB messages are adjusted by the WAV output.
- ♦ Adjust these Playback controls so that the maximum output level on peaks is about 6 dB below the maximum output level of the sound card. This prevents distortion from being created in the sound card. One good way to do this is to send RTTY or PSK tones from the computer (using a program like MMTTY or DM780) and view them on a scope. Slowly increase the level until you just begin to see clipping, then back off the level to get half the voltage.
- ♦ Adjust the mic gain in the radio for good modulation levels.

Feeding Receive Audio To Your Computer Some computer sound cards can be set for either a mic level or line level input, while others have only a mono mic input. All of the outputs of a modern ham transceiver are line level outputs, but some are affected by the front panel audio gain control and some are not. Do all of the following:

- ♦ Plug all of the interconnected equipment into the same power outlet or to outlets in the same backbox, and bond together all of the interconnected equipment with heavy copper braid, as described above.
- ♦ Choose an output of your radio that is not affected by the front panel volume control. Outputs designed for the connection of RTTY, packet, phone patches, or other external gear usually fit this requirement.
- ♦ Make up a cable that connects this output to the input of your sound card. Pay careful attention to the guidelines above for ***Unbalanced Audio Interfaces***.
- ♦ Look for a setting in the control software for your sound card that turns off the mic preamp in the sound card. On a Windows PC, the setup screen can be accessed by clicking on the speaker icon on the taskbar, then selecting Options, and then Recording. You should see a screen with volume controls for various inputs to the sound card. Somewhere on that Recording screen (or maybe buried in a sub-menu) should be a way to turn off the mic preamp. On my IBM Thinkpads, I must remove the "check mark" next to "Mic Boost."
- ♦ Tune in a station so that you have normal audio coming out of the radio into your headphones or speaker.
- ♦ Adjust the input fader of the sound card so that the level indicator (if there is one) peaks about 6 dB below maximum. If there is no level indicator, adjust the input level to the maximum it will go without audible distortion.

Wired or Wireless Ethernet? There are several parts to the answer to this question, all ending with, "it depends." My advice is to try wireless networking, and use it for as much of your system as you can make work reliably.

- ♦ Wireless Ethernet systems operate in the 2.4 GHz band and above. I've never heard of the 2.4 GHz link causing or receiving ham interference, and the likelihood is thin, except possibly on the 2.4 GHz band itself.
- ♦ I've seen systems work for 1,000 ft, but conductive (or absorbing) obstacles can make the RF link unreliable at 50 ft or less. Some newer models of Wireless Access units built to FCC Rules that permit higher power and detachable gain antennas can provide greater range and/or improved reliability.

- ◆ While the Ethernet circuitry in a wireless router can be just as strong a source of RF noise as any other Ethernet box, a wireless system will usually generate the least HF and VHF trash in our antennas because it reduces the number and length of data cables that can radiate. Be prepared to use chokes to suppress any noise radiated by cables connecting the wireless router to the cable or DSL modem, and also for inadequately shielded internal wiring that radiates trash.
- ◆ Some older computers, operating systems, and hardware may not operate (or operate reliably) with a wireless connection. Wireless connections can also be slower, and operating system conflicts can be difficult to solve.

DIN Connectors It is hard to find good quality DIN connectors to mate with interface and control jacks on the back of ham rigs. Nearly all DIN connectors sold in the ham marketplace are junk. These junk connectors have two serious defects that makes them useless; 1) the plastic melts when you try to solder to them; 2) you can't solder to them – the metal used for the pins is an alloy that doesn't take solder! These junk connectors are cheap, selling for around a buck, but they're worthless. Real DIN connectors are still made by Switchcraft and Tuchel, and sold by reliable electronics vendors like Newark and Allied. They cost a lot more (\$5-\$7 each, depending on the number of pins), but they work! GM types have a two-piece metal shell held together with a plastic barrel. BL types have a nickel diecast handle and a heavy duty cable clamp.

Acceptable low cost DIN connectors The YCCC team that put together the K1XM SO2R box found a source for low cost DIN connectors made by Kobiconn. The 8-pin 270° male plug is Mouser Part number 171-0278. They bought 166 of them at 52cents each. These connectors solder well – their only shortcoming is that the two pieces of their "clamshell" don't mate very well, so I wouldn't want to use them in an application where they needed to be plugged and unplugged fairly often, but they're fine if you plug them in and leave them alone.

"Phono" Connectors and 1/8-inch Audio Connectors I know of only two good quality manufacturers of these connectors – Switchcraft and Neutrik. These Neutrik and Switchcraft parts are sold mostly by pro audio vendors; one of the best Full Compass Systems of Madison, WI. These Neutrik connectors are good quality, inexpensive (about \$1), and work well for ham audio interconnects. Their only shortcoming is that their contacts and strain relief clamps are too small for larger cables – for that, you need the much more expensive Switchcraft parts (about \$3), which are also more robust.

Cable for Audio Interconnects Miniature coax is an excellent choice for unbalanced interconnections. Impedance doesn't matter in this application. For balanced connections, use braid-shielded twisted pair. Belden 1901A and Gepco XB401 are the best of this type that I know of.

Cable Mount Male DIN Connectors Used with Ham Gear

<u>Configuration</u>	<u>Switchcraft Part Nr</u>	<u>Some Common Uses</u>
4 pins at 210°	09BL4M, 09GM4M	FT1000MP RTTY FSK
5 pins at 180°	05BL5M, 05GM5M	FT1000MP Packet
5 pins at 240°	12BL5M, 12GM5MX	
6 pins at 240°	12BL8M, 15GM6MX	TS850 Acc 1
7 pins at 270°	15GM7MX	TS850 Remote, ICOM Pwr Amp, Yaesu DVS
8 pins at 262°	20BL8M, 20GM8M	Yaesu Band Data
8 pins at 270°	15BL8MX, 15GM8MX	

Cable-Mount 1/8-in and Phono Connectors

<u>Description</u>	<u>Switchcraft Part Nr</u>	<u>Neutrik Part Nr</u>
3-ckt male 1/8-in plug	35HDNN	NYS231BG
2-ckt male 1/8-in plug		NYS226BG
3-ckt female 1/8-in jack		NYS240BG
Phono male plug	3502	NYS352
Phono female jack	3503	

RF Feedback Virtually all RF feedback (also called "RF in the shack") has a pin 1 problem as the root cause. (See Figs 2, and 3 in Chapter One, and the associated discussion.) A few years ago, I acquired an FT1000MP and got reports of RF feedback running 1.5kW on 75M and 15M SSB. The 15M transmitting antenna was a dipole (with a DXE "string of beads" balun) 150 ft from the shack! I identified the cause as a pin 1 problem at the mic jack, using the simple test outlined below.

Testing for RF Pin 1 Problems: Set up a tunable RF generator for 100% 1 kHz (or 400 Hz) AM and maximum output (1 volt into 50 ohms is enough). Connect the center conductor of the coax from the generator to the shield connection point at the radio, and connect the generator coax shield to the chassis of the radio. Set the radio to transmit SSB at very low power, and not at a frequency where you have RF feedback. Listen to your signal on another radio while you tune the generator over the frequency range where you have RF feedback. If you hear the 1 kHz (or 400 Hz) modulation, you have a pin 1 problem on that shield connection. Repeat this test for every connector on the radio that has (or could have) a cable plugged into it. For each connector that you are testing, temporarily remove the cable connected to it while you are testing it.

This test can be used to test any audio and video input and output connectors for RF pin 1 problems, not only the audio interfaces of ham transceivers. With video equipment, the 1 kHz modulation may show up as horizontal bars in the video, or as 1 kHz (or 400 Hz) in the audio, or both. See <http://audiosystemsgroup.com/AESPaperNYPin1-ASGWeb.pdf> for more on RF pin 1 testing.

RF feedback can also be caused by audio interfaces like those used for SO2R contesting, and to interface computers to radios for RTTY, PSK31, and other digital modes. If you don't find a problem in your transceiver (or if you find and fix it but still have RF feedback), be sure to test any of these interfaces that you might be using (and the computer sound cards) for pin 1 problems.

Solving RF Feedback Caused by Pin 1 Problems RF feedback is caused by poor RF rejection in one or more pieces of gear in your ham station. In earlier chapters, we learned that RFI caused by pin 1 problems can be solved in two ways:

- ♦ Rewire the connector so that the shield goes to the chassis, not the circuit board
- ♦ Block the current with a ferrite choke

Rather than rebuild the radio, I killed the RF feedback in my FT1000MP by winding 7 turns of the mic cable around a #31 2.4" o.d. toroid.

Chapter 9 – A Short Tutorial on Fields

Fields Electrical systems produce three kinds of fields – *electric*, *magnetic*, and *electromagnetic*. An *electric* field is what is present in the relatively non-conducting space between two charged objects (for example, between the plates of a capacitor).

A static *magnetic* field exists around a permanent magnet. Static (DC) and time-varying (AC) *magnetic* fields surround a wire that is carrying current. Contrary to what your high school physics teacher may have told you, a field produced by an electric current is a *magnetic* field, not an *electromagnetic* field.

An *electromagnetic* field is the combination of a time-varying *electric* field and a *magnetic* field of the same frequency at right angles to each other and 90 degrees out of phase with each other.

Wave Impedance – Near Field and Far Field The *wave impedance* of a field defines the relationship between the energy in the two fields. Wave impedance determines how well shielding will work (and what kind of shielding will work). (see Ott for an excellent discussion of wave impedance and shielding effectiveness.)

In the *Far Field* of a signal source (including a transmitting antenna):

- ♦ the wave impedance is the impedance of free space – 377 ohms
- ♦ the energy contained by the two time-varying fields is equal, and is traded back and forth between the two fields at the frequency of the signal
- ♦ The field will move through free space at the speed of light – that is, it is a radio wave

In the *near field* of any source, either the electric field or the magnetic field will dominate (that is,

contain most of the energy), depending on how the field is produced. Most "baseband" sources (motors, transformers, power wiring) and many antennas are magnetic sources; a few RF sources may be electric sources. The wave impedance is very low in the near field of a magnetic source, and very high in the near field of an electric source.

The transition between near field and far field is a gradual one. For sources that are *small as a fraction of a wavelength*, the transition begins at $\lambda/6$ from the source. For larger sources (like a line source), the transition will be at a much greater distance. In the far field, the power in the field falls off as the square of the distance. In the near field, the dominant field falls off much more rapidly until the two fields are equal.

[One huge error in the application of FCC Part 15 Rules to BPL is that the rules are designed around the physics of a point source, but BPL systems are, in effect, a line source, so field strength falls off far more slowly. The improper application of the Rules allows interference levels to be tens of dB stronger than the authors of the Part 15 Rules intended.]

The wave impedance becomes important when we are attempting to deal with interference in the near field of the source. We can state two generalities.

- ♦ Virtually all electronic equipment is in the very near field of any *power-related sources* that are strong enough to cause interference, and nearly all those sources are *magnetic* sources.
- ♦ Most electronic equipment in the far field of most radio sources.

An important exception to these generalities occurs when an antenna is much closer than usual to susceptible equipment. $\lambda/6$ is about 84 ft on 160 meters, 44 ft on 80 meters, 22 ft on 40 meters, etc. The near field of a 160 or 80 meter antenna on an urban or suburban lot is likely include the living space of the ham and one or two neighbors; in a condo or apartment, a 40 or 20 meter vertical antenna may have consumer electronics within its near field. These are only "rule of thumb" guidelines – our antennas are not simple point sources, so the transition distance will not be so simply defined. An understanding of near field and far field behavior simply contributes to our understanding of how noise and RFI couple into systems, and which suppression methods are most likely to be effective in any given situation.

ACKNOWLEDGEMENTS

Thanks are due Ron Steinberg (K9IKZ), whose AEA analyzer was on loan to me for two years, giving me the capability to begin poking around this puzzle, to Dr. Leo Irakliotis (KC9GLI) for finding the rare Snelling text (in the third basement of the University of Chicago library) that was the key to understanding ferrites; to someone on a ham radio email list who pointed me to the Snelling text; and to Fair-Rite Products Corp, for providing every sample I requested and publishing extensive technical data on their products. Henry Ott, WA2IRQ, Dean Straw, N6BV, and Garry Shapiro, NI6T, reviewed various versions of the manuscript. The most important contributions to this work were made by a researcher who has done, and continues to do when he has time, the excellent measurements presented herein. He has chosen to remain anonymous. The ham radio community owes him quite a lot. Kevin Rowett, K6TD, assisted with measurements of coaxial chokes.

POSTSCRIPT

It is impossible to overemphasize the importance of sharing what we learn. The initial impetus for my work was a series of anecdotal reports of RF interference on an email reflector for engineers and technicians working in pro audio that not only got me interested, but also gave me clues about possible causes. A year or two later, I made contact with the aforementioned anonymous researcher when both of us shared our work on an email reflector about 8 years ago.

As a result of having published earlier versions of the document you are reading, and of making numerous presentations to ham clubs, I was contacted by engineers from the CIA, who I subsequently hosted in my shack and briefed on my work. Recently, the leader of that group sent me a pdf of an unclassified report prepared by a Department of Defense engineer in 1966 on the topic of using ferrite common mode chokes to isolate antennas from their feed lines. Among the key conclusions were 1) common mode isolation of the antenna from the line is highly desirable; 2)

5,000 ohms of common mode choking impedance is a suitable design goal; 3) the simplified equivalent circuit of a ferrite choke is a parallel resonant circuit; 4) the accuracy of the equivalent circuit can be improved upon at low frequencies by adding resistance in series with the inductor; 5) the low Q parallel resonant circuit near resonance is a good way to provide that choking impedance; 6) inductance and stray capacitance can be used to control the resonances, by varying the material, the number of windings, and the winding style; 7) increased conductor diameter increases stray capacitance; and 8) three chokes in series, each tuned to a different part of the frequency spectrum, can satisfy the 5,000 ohm design goal from 2-30 MHz.

For all practical purposes, there are only three important differences between the 1966 work and my own are

- 1) the properties of the specific ferrite materials available in 1966 and 2002
- 2) the author of the 1966 report seems not to have recognized the behavior of the ferrite core as a dielectric (and the resulting contribution to stray capacitance), or of the fundamental resonant property of a single turn choke with the capacitance associated with that dielectric;
- 3) I published my work widely, first as peer-reviewed research papers to the Audio Engineering Society, and later on my website to both the audio and ham radio communities as a whole. I've seen no evidence that the DoD report was ever circulated outside the Defense community.

As a result, even though it was excellent, that 1966 DoD report appears to have disappeared into oblivion, while my work is finding its way into the ARRL Handbook. Since I first published this document three years ago, nearly 1 million copies have been downloads from my website, and I've received many useful questions and comments that have allowed me to learn more, find mistakes, filled gaps in my thinking, and given me more ideas to investigate.

ABOUT THE AUTHOR

Jim Brown got interested in music and radio as a teenager, falling in love with jazz and Bach, and qualifying for his Novice license (WN8FNI) before his 14th birthday. Three years later he obtained Amateur Extra Class and First Class Radiotelephone licenses, and entered the Electrical Engineering program at the University of Cincinnati. He received the BSEE in 1964 and has worked in broadcasting and professional audio since 1960. Since 1985, his consulting practice has specialized in the design of sound systems for worship, performance, and sports facilities. More recently, his focus has expanded to include research and consulting on EMC.

Jim is a Fellow of the Audio Engineering Society (AES), and a member of the Acoustical Society of America, the Society of Broadcast Engineers, and the Society of Motion Picture and Television Engineers. He has presented invited papers and workshops to all of those societies, and to the IEEE EMC Symposium. He is a member of the AES Technical Committee on Acoustics and Sound Reinforcement, and the AES Standards Committee's Working Groups on Microphones, Intelligibility, Acoustic and Sound Source Modeling, Digital Audio Transmission, and Audio Interconnection. He is Vice-Chair of the AES Standards Committee Working Group on EMC and Chair of the AES Technical Committee on EMC. After 42 years in Chicago, he relocated in 2006 to Santa Cruz, where he is active on the ham bands as K9YC, and recently served a term as Vice-President of the Northern California Contest Club.

BIBLIOGRAPHY

Henry Ott, *"Electromagnetic Compatibility Engineering,"* Wiley, New York, 2009

Henry Ott, *"Noise Reduction Techniques in Electronic Systems,"* Second Edition, Wiley, New York, 1988

Clayton Paul, *"Introduction to Electromagnetic Compatibility,"* Wiley, New York, 1992

The Audio Systems Group, Inc. website includes numerous tutorials and applications notes on RF interference, and a tutorial on AC power systems. <http://audiosystemsgroup.com/publish.htm>

Neil Muncy, *"Noise Susceptibility in Analog and Digital Signal Processing Systems,"* J. Audio Engineering Soci-

ety, vol 43, No 6, pp 435-453, 1995, June

Bill Whitlock, "*Balanced Lines in Audio Systems: Fact, Fiction, and Transformers*," J. Audio Engineering Society, vol 43, No 6, pp 454-464, 1995, June

Fair-Rite Products Catalog, <http://www.fair-rite.com> This 200-page catalog (online as a pdf) is a wealth of product data and applications guidance on practical ferrites. This company is a class act. The vast majority of ferrite parts available at retail in North America are made by Fair-Rite.

Chuck Counselman, W1HIS, *Common Mode Chokes* Self published 2006

E. C. Snelling, *Soft Ferrites, Properties and Applications*, Chemical Rubber Publishing, 1969 This, like all of Snelling's books, is geared toward non-suppression applications of ferrites. Lots of math and physics. All are long out of print.

E. C. Snelling and A. D. Giles, *Ferrites for Inductors and Transformers*, Research Studies Press, 1983 Even more math and physics.

E. C. Snelling, *Soft Ferrites, Properties and Applications, Second Edition*, Butterworth-Heinemann, 1989 I've never seen this book, but I'd love to.

Jerry Sevick, W2FMI, *Transmission Line Transformers*, Fourth Edition, Noble Publishing, Atlanta 2001

Jerry Sevick, W2FMI, *Building and Using Baluns and Ununs*, CQ Communications, 1994

Doug DeMaw, W1FB, *Ferromagnetic Core Design and Applications Handbook*, Prentice Hall, 1996

Appendix 1 – Ferrites Useful to Hams For Suppression and Chokes

Fair-Rite Part Nr	Form	Dimensions (inches)			Mix	Approx Cost		Freq Range (MHz)	
		o.d.	i.d.	Length		250 pc	1,000 pc		
2631803802	Toroid	2.4	1.4	0.5	#31	< \$5	< \$3	0.5	200
2643803802	Toroid	2.4	1.4	0.5	#43	< \$4	< \$2	5	250
2661803802	Toroid	2.4	1.4	0.5	#61	< \$4	< \$2	50	150
2631625102	Cylinder RG6	0.625	0.312	1.125	#31		\$0.65	1	300
2631102002	Cylinder RG8	1.02	0.505	1.125	#31		\$1	1	300
0431178281	Clamp-On RG8X	0.648	0.354	1.125	#31			1	300
0431164181	Clamp-On RG8	1.22	0.51	1.55	#31	\$3.25	\$2	1	300
0431177081	Biggest Clamp-On	2	1.03	1.474	#31	< \$11	< \$7	1	150

Notes:

- 1) Use of these ferrites below 100 MHz requires multiple turns, multiple cores, or both. Study the text and the data.
- 2) #61 material can be used for transformers that must handle power. A single 2661803802 core can easily handle 100 watts with suitable windings. All other listed materials are recommended only for suppression, choking applications, and small signal transformers.
- 3) The excellent Fair-Rite catalog can be downloaded as a pdf from <http://www.fair-rite.com> Costs are based on quotes during 2006.

Manufacturer's Published Data

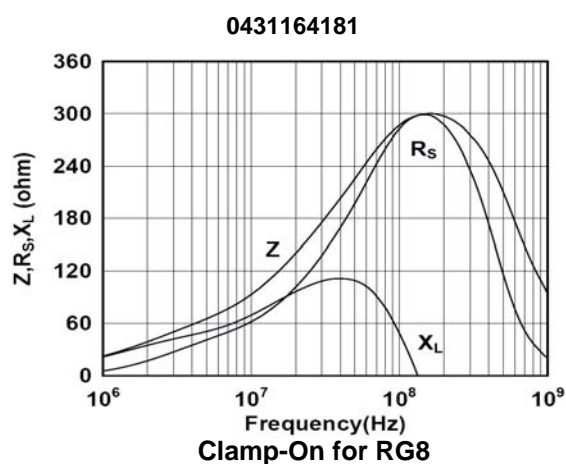
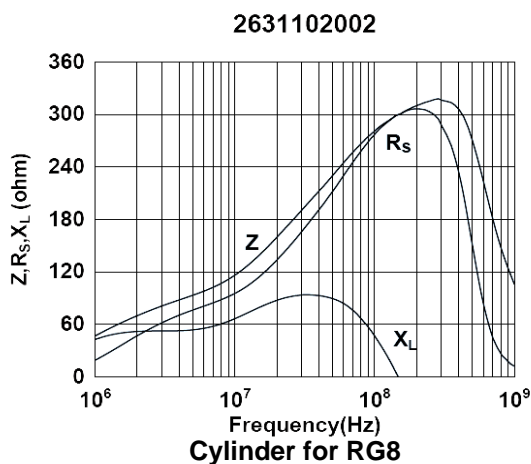
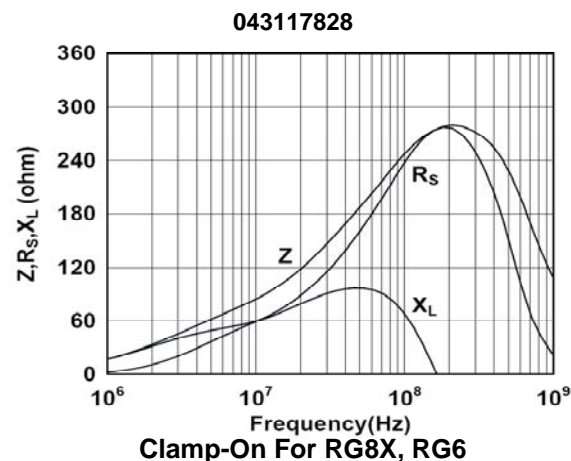
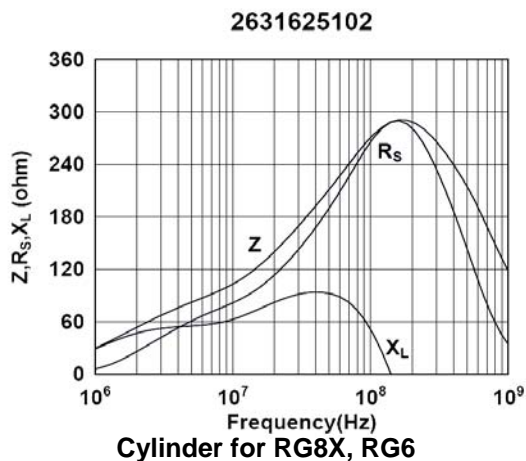

Measured HF Data for Chokes on 2.4" o.d., 1.4" i.d. Toroids

Note: All of these data apply to chokes wound with small diameter wire. Chokes wound with cable diameters larger than about 0.2" (RG58) have more stray capacitance, moving the resonance down to a greater extent than those wound with small wire. See Figs 40 – 45 for data on some larger chokes.

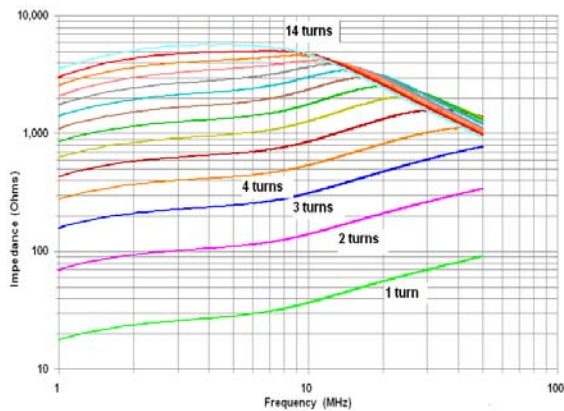

#31 Impedance

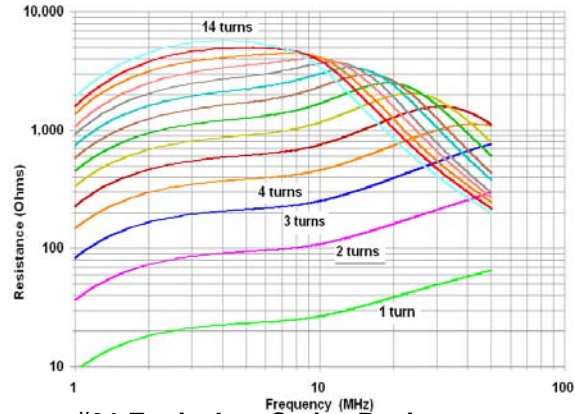

#31 Equivalent Series Resistance

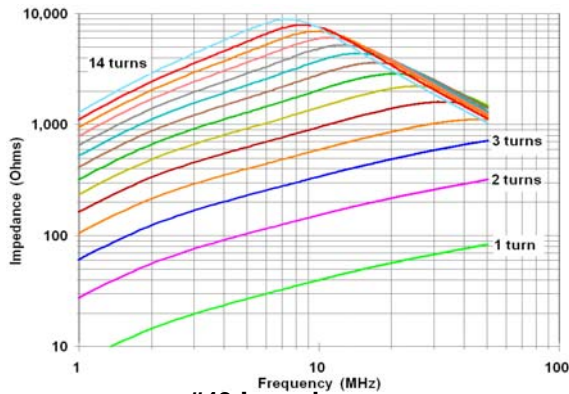

#43 Impedance

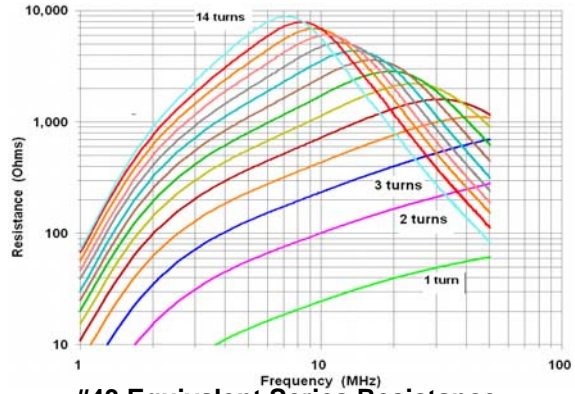

#43 Equivalent Series Resistance

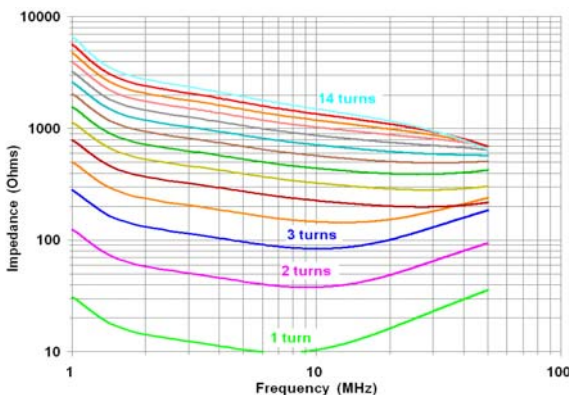

#77 Impedance

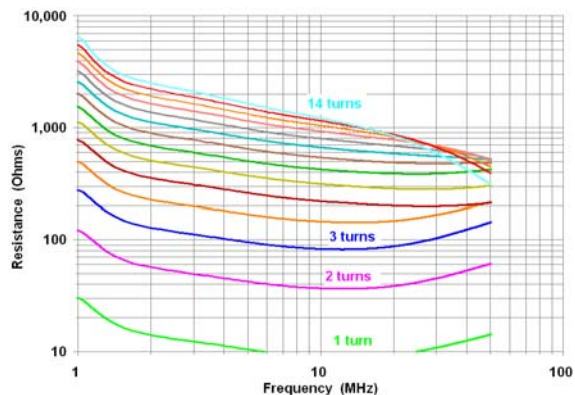

#77 Equivalent Series Resistance

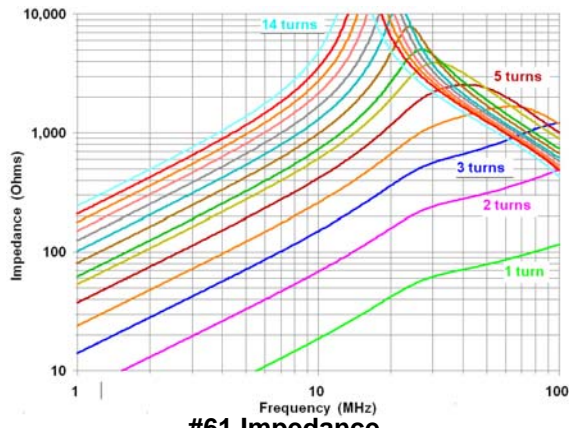

#61 Impedance

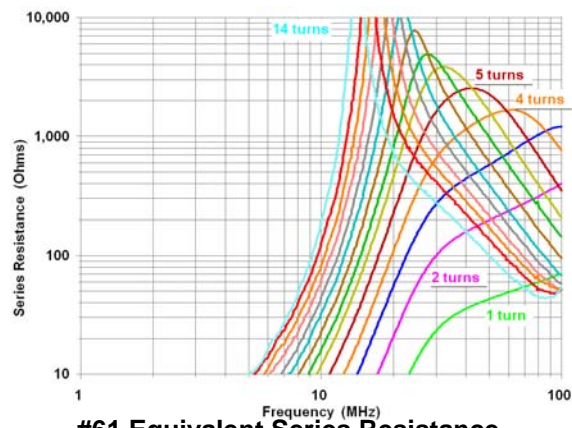

#61 Equivalent Series Resistance

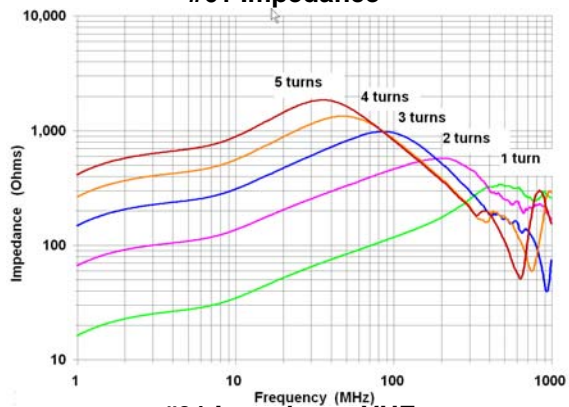

#31 Impedance VHF

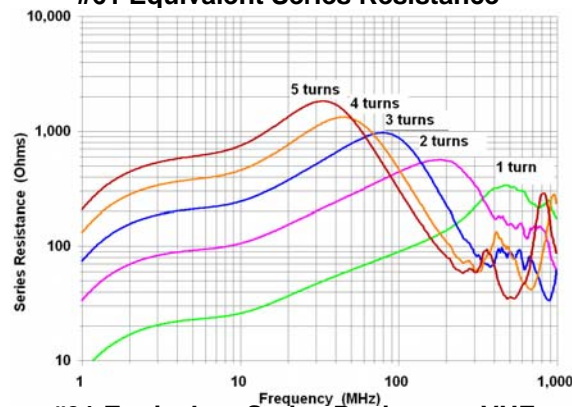

#31 Equivalent Series Resistance VHF

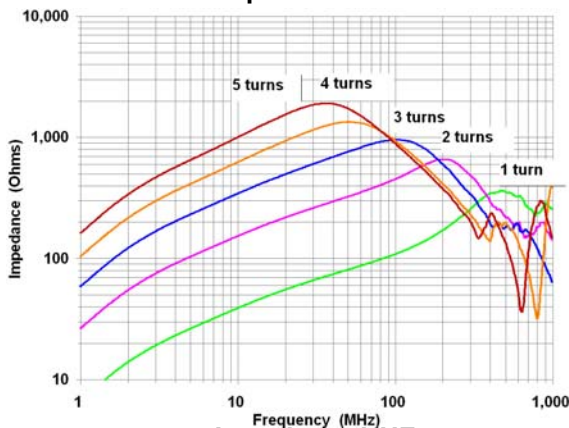

#43 Impedance VHF

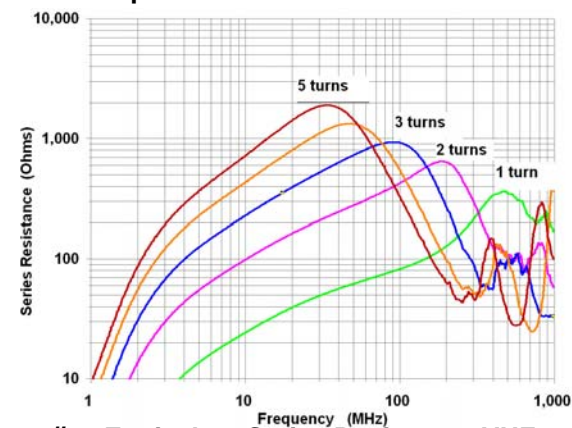

#43 Equivalent Series Resistance VHF

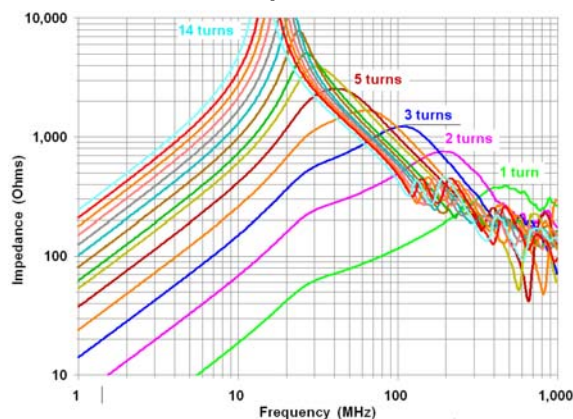

#61 Impedance VHF

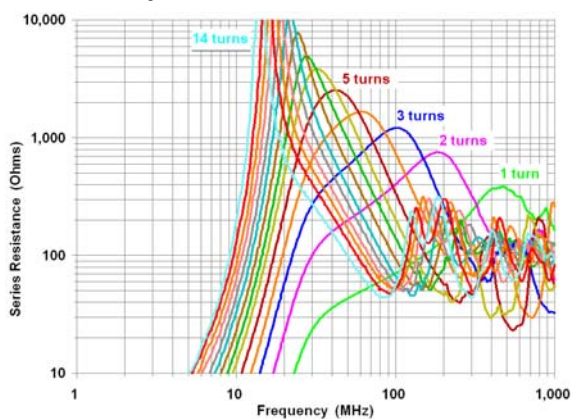

#61 Equivalent Series Resistance VHF

Measured HF Data for #31 "Biggest Clamp-On"

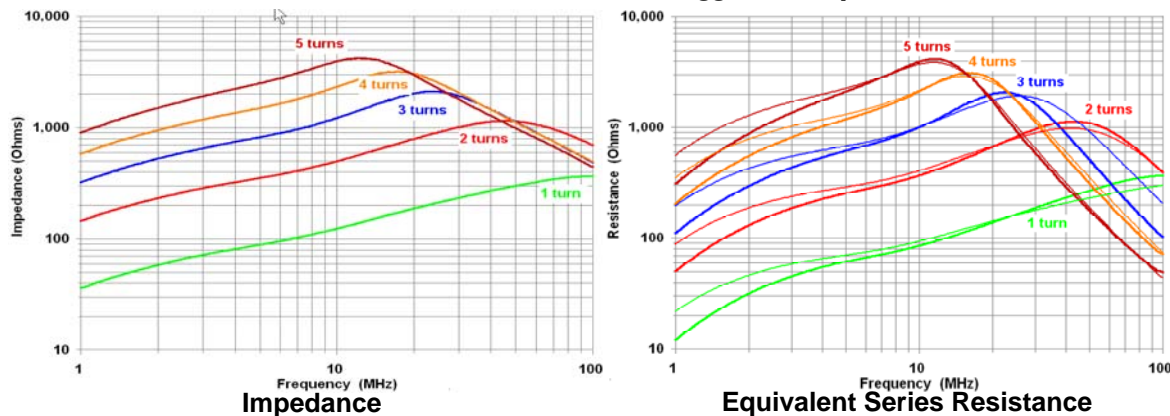

Buying Ferrites

Sadly, nearly all vendors selling ferrites in the ham marketplace are selling the wrong parts, and at obscenely high markups (4-5X typical). There are much better ways to buy. All of the ferrite parts described in this tutorial are made by Fair-Rite, a great company based in upstate New York. Fair-Rite has an excellent website with an extensive on-line catalog and a list of distributors. ***If you are willing to buy in quantity, you can do business with these distributors and buy at much lower cost.*** Established industrial electronics distributors like Newark, Allied, Lodestone Pacific, and Kreiger Components have all provided good service and competitive pricing on Fair-Rite parts. Don't bother these companies with onesy-twosey orders – all you'll do is make them angry. Consider 20 pieces a minimum order, and combine orders with other hams for quantity discounts. Ferrites are brittle and easily broken in shipping if not carefully packed. To minimize breakage, try to buy in box quantities that are packed by Fair-Rite.

Better yet, join or organize a group purchase with a ham club that includes lots of active HF operators, DX chasers, and contesters. These guys are most likely to have RFI problems, and to be pushing to optimize their stations to pull weak signals out of the noise. If you're active on HF or 6M, you can use a lot ferrites – taming RFI to home entertainment systems, and minimizing the noise you hear in your radio from noisy equipment in your home and the homes of your neighbors. Designate a club member who has worked in industry buying electronic parts to do the business with the distributor(s), and another member to collect the money and distribute the parts once they arrive. Expect to pay sales tax and shipping.

How Many Ferrite Parts Should You Buy? Use the table below to estimate how many ferrite parts you can use over a period of several years.

Number of HF antennas (include receive antennas)	
If you run 100 watts or less, multiply by 10	
If you use a 400-600 watt amp, multiply by 20	
If you use a 700-1,500 watt amp, multiply by 30	
If you chase DX or work contests, multiply again by 2	
If you operate 6 meters with 100 watts add 10	
If you operate 6 meters with 500 watts add 20	
If your antennas are close to your living space or your neighbors (like on a city or suburban lot), multiply again by 1.5	
Multiply the largest number above by 2/3 and buy this quantity of #31 2.4" toroids (Fair-Rite #2631803802)	
Buy one #31 "biggest clamp-on" (Fair-Rite #0431177081) for every three toroids	
Buy one #31 RG8-size clamp-on (Fair-Rite #0431164181) for every two toroids	

Appendix 2 – W8JI on Baluns

> I also read W2FMI's book and I would have to agree that something isn't right about the W2DU > type Balun. I experienced heating and a rise in SWR when using a KW and an under 2:1 SWR but > not flat. It would heat up and the standing wave would rise over 2:1. This is not to say that all > bead baluns are bad. I had heard good things about the Force 12 version. Perhaps it uses a > different ferrite material.

Walt's balun is based on good engineering for choking, but if you look at it closely there is no headroom for power. I suspect Walt never caught that because he mostly runs low power. There are certainly many cases where his balun would work OK, but 73 material or ANY material with high loss tangent is the wrong material for QRO or for use where the core is involved in handling any high flux density.

> I built several of the W1JR type of Baluns and have had no problem with heating. I have had a > problem finding an inexpensive enclosure. I have tried using 3" PVC caps and plugs and have > about \$5 in the enclosure. However, I created another problem. Weight of the enclosure and the > core/coax with connectors is a bit much for a dipole. An inverted V or mounting on a beam is not > a problem.

There is no need for the criss-crossed winding style, a single layer solenoid winding measures nearly the same. Some articles and books tell you any stray C across the balun reduces choking, but the opposite actually happens. You just have to be careful and not use such a large winding that the self-resonant frequency of the balun is lower than 1/2 of the highest operating frequency.

The cheapest balun for a given impedance and power rating is still an air-wound coil of coax on a PVC drainpipe.

> I have also had excellent success with a coil of coax. When ur lighting every florescent tube within a block at 2 AM while on 80m with a flat SWR. This will cure it.

If you use multiple turns through a core, the impedance goes up by the square of the turns increase. If you stick them through a string of beads, the increase in impedance is linear with length and has almost nothing to do with bead thickness. An air wound choke is somewhere between unity ratio and squared impedance as turns are increased, depending on mutual coupling between turns.

A string of 43 material beads 36 inches long has the same common mode impedance as a stack of 43 cores 1 inch tall with 6 turns of coax. The string of beads will handle more power, because it has more surface area exposed directly to cooling air no matter how thick the beads are (beyond a certain limit).

The more stress the balun has, the lower the μ_i of the core you should use. At the feedpoint with high power, a low- μ_i low-loss-tangent core is generally best, like air or a 61 material. This is especially true if the feedline parallels the antenna, or if the element is off balance, or if the element impedance is high.

In a coaxial line connected the normal way near the shack (like in the second chokes K3LR uses), a string of 73 material beads would almost certainly be acceptable no matter what the power level.

The feedline should be grounded to the tower or another ground as soon as possible after the balun, only on the side of the balun closest to the shack if possible.

I use air chokes, or 61 material cores at transmitting antennas. I use 73 or 75 material cores for receiving and in-the-shack or "down the cable a distance" isolation.

73, Tom W8JI

[K9YC Note: This email exchange occurred before the introduction of Fair-Rite's #31 material. Tom now uses #31 in a number of applications. As to W2DU's chokes and power handling – the 50-bead choke is under-designed for high power work because its impedance is too low. Walt's larger choke with 100-300 beads would have solved that problem, but it was the cheaper one that became popular. See discussion of these issues in Chapter 6.]

Appendix 3 – John Petrich W7FU on Baluns

Subject: C-31XR Balun ..Author:John Petrich <petrich@u.washington.edu> 13-Jan-2001

Hi Greg,

Yes, I am familiar with the W1JR balun and have used it in some applications. It was good 30 years ago, it is still good today. The only reason that it is not as popular as it once was, is that the bead baluns are easier to construct and harder to goof up on. There may be a small advantage in terms of bandwidth for the bead baluns. In some applications, bandwidth is very important. In other applications, bandwidth is really not important at all.

I know what you mean about unrecognized balun heating. So many baluns are located up at the antenna feedpoint and the heating is only discovered after the balun has failed. Antennas can be properly constructed yet it is of major importance to pair the balun, the antenna and the band of operation correctly to avoid balun heating and unwanted feedline radiation. Feedline radiation isn't always a problem. Wanted feedline radiation can make for a useful antenna i.e. G5RV.

Balun heating is the result of common mode currents flowing on the outside of the coax shield. These currents are then dissipated in the real component of the complex common mode impedance characteristic for that balun. There is no other source for heating for the ferrite beads. This heating problem occurs just the same way and for the same reason with all ferrite baluns, whether they are constructed with ferrite toroids or ferrite beads. The phenomenon is the same. It is interesting, if you carefully examine an overheating bead balun, the beads closest to the high impedance connections are the warmest. The beads closest to the low impedance connections are the coolest. It is as if each little bead functions as an individual little attenuator element. The entire stack of ferrites does not act like a resistor. The power from the common mode current is not dissipated uniformly as it would along a purely resistive element.

There are two independent factors that contribute to common mode current flow and the resultant risk of balun heating:

1) INSUFFICIENT COMMON MODE IMPEDANCE TO CHOKE OFF COMMON MODE CURRENT FLOW: Anytime, repeat "anytime", one of these 800 ohm common mode impedance bead baluns is connected across a high impedance load, such as a 80 meter doublet excited on 40 meters, there is the risk of severe balun overheating. The same goes for trying to operate a old style tribander on 17 or 24 meters with a ferrite balun. Low power operation won't heat the balun, BUT, the common mode current is still flowing, and the system could be operating at a disadvantage. This limitation from the balun's common mode impedance in a high impedance environment is BY FAR THE MOST SIGNIFICANT FACTOR that contributes to bead balun overheating. High power makes the heating problem easier to recognize. Low power doesn't cause as much heating but the system may not be functioning in an ideal manner. But, "everything works." A better solution for a balun in a high impedance environment is to use one of those coiled coax or "Badger", baluns. This particular style of balun is capable of exhibiting extremely high common mode impedance values if properly constructed and tested for the frequency of use. Just like an old antenna tuner of years gone by.

2) FERRITE MIX: Yes, ferrite mix can make a difference, but don't get overly excited on this one. Any importance that ferrite mix has on balun heating is not because one mix is "better" than another, or one mix is "worse" than another. The reason that ferrite mix can contribute to balun overheating problems is because of #1 above- Insufficient Common Mode Impedance. The Force-12 balun, I'm guessing, acts like a string of #43 mix ferrite beads. The Maxwell, W2DU, bead balun uses a string of #77 mix ferrite beads. The Force -12 balun has a good peak common mode impedance from 40 meters to 10 meters. The Maxwell bead balun has a useful peak common mode impedance from 160 through 15 meters. There is substantial overlap for both and both are good. The Maxwell balun might not have enough common mode impedance on 10 meters and overheat in some 10 meter applications. The Force 12 balun might not have enough common mode impedance for a 160 meter installation and overheat in some applications on that band. I haven't actually tested each balun side by side in the antenna situations I have referred to but I am extrapolating from their common mode impedance curves.

The key to reducing balun overheating probably lies with pairing up the antenna (and its feed point impedance), and band of operation, with a balun having sufficient common mode impedance to choke off common mode current flow. The standard of comparison between "current mode" baluns is their measured common mode impedance at the frequency of use. Some "current mode" baluns have low common mode impedance compared to other baluns. I have only tested the Force-12 and Maxwell baluns and they exhibit common mode impedances of about 800 ohms. Unfortunately, the various manufacturers never publish the common mode impedance characteristics of their baluns. I think that it is very very very hard to get common mode impedance values greater than 800 to 1000 ohms using low Q type #43 and #77 ferrites. Maybe I don't know enough, so take that statement with a grain of salt. One can get relatively high common mode impedance by coiling coax on a higher Q #61 ferrite toroid. The air coiled coax, "Badger, balun or an old fashioned antenna tuner will give the highest common mode impedance values that I know of.

Let me know your thoughts, Greg.

John Petrich, W7HQJ [now W7FU]

Appendix 4 – Joe Reisert on Baluns

Re: Topband: 160 Meter BALUNS From: Joe Reisert <W1JR@arrl.net> Mon, 22 Dec 2003

Hi Tom,

A follow up to my prior EMail on a solenoid baluns.

Regardless of whether 50 feet of RG8X wound on a solenoid (tube) is proper to use a balun or not, I'll leave that up to you and W8JI to decide. I guess you some would describe this type of balun as a choke.

Now, here is some more theoretical information and measurements etc. that maybe of interest to some for the engineering types on this reflector. This maybe helpful to design similar types of solenoid baluns at other frequency bands.

50 feet of RG8X coax is a good starting point for a 160 meter solenoid (choke) balun for many reasons. If you close wind the coax on a 4.5" OD (I mistakenly said 4" in my prior EMail) standard white PVC tube, you obtain an impedance of about 650 Ohms (as measured on an HP Network analyzer). This means that you are above the 500 Ohms (and well above 250 Ohms) impedance that most experts feel is adequate for a balun impedance.

At 80 meters, the same solenoid balun will have a measured impedance of about 1300 Ohms. However, depending on how tight you make the turns, a resonance will be noted somewhere between 12 and 15 MHz. Hence, 50 feet of coax is probably only good for 160 through 30 meters. Use less turns if only for higher bands (see below). It looks like a 4 or 5:1 ratio of lowest frequency to highest useable frequency is a good rule of thumb.

To carry on further, 50 feet of RG8X will amount to approximately 38 turns on a 4.5" OD former and the winding will be approximately 9.25" long. If you plug these numbers is into most standard equations to calculate inductance, you will calculate an inductance of approximately 60 micro Henries. Using the standard formula for reactance: $X_L = 2 \pi F L$, yields about the same impedance as measured above. Pretty nifty to get such agreement! So, you can see that don't need fancy measuring gear to make a solenoid balun for any band. Just decide on how high an impedance you want (but not too high-see below) and make sure that you don't put on too many turns so resonances will occur above rather than in band!

Some may ask if RG58 is OK for a solenoid balun. Sure it is but for lower power than RG8X. Since it is slightly smaller in diameter, 50 feet h a slightly higher impedance. Since the power handling ability of coax goes down as frequency increases, it maybe safer to use Teflon (RTM) type coax such as RG303 if you are running high power, especially at 80 meters and above. RG8 will also be OK but it is larger in diameter so more coax will be required. You can make your own calculations on this one. I wouldn't recommend foam RG8 coax as it may deform on such a small diameter. However, if you use a larger diameter tube, that will work with RG8 and since the diameter is larger, the impedance will increase accordingly. Use the standard inductance equations.

I made a solenoid balun with 25 feet of RG303 teflon (RTM), about 20 turns on a 4.5" tube, and the first measured resonance was about 24 MHz. This balun would be great, even at high power, for 80 through 15 meters. Again, about a 5:1 frequency range.

Some purists will say to space the turns, for example, by the diameter of the coax. This maybe less of a problem for flash over if lightning hits. I'll leave that up to you to decide. However, using the info above, this would calculate (using standard inductor equations) to about 33 micro Henries of inductance for space windings (and an impedance of only 375 Ohms), well below that normally suggested for a 160 meter balun. Hence, more coax or a larger diameter tube is required.

Finally, what about laying the balun on the ground. I'd recommend against that simply because that at least may lower the self resonance frequency. This is the old story that you shouldn't place objects near (1-3 diameters away) an inductor (which is what a solenoid balun is on the outside shield).

I hope this info is of interest and help. There will always be the disagreements over whether to use ferrite beads, ferrite toroids or solenoid baluns. No one size fits all! However, for those interested

in designing their your own solenoid type baluns, I've hopefully given some info on how to "roll your own."

Happy holidays and best of DX in 2004.

73,

Joe, W1JR

Appendix 5 –Grounding and Lightning Protection

Grounding for lightning protection is another one of those widely misunderstood topics. This author is not an expert on lightning protection, so the following discussion should be taken only as a starting point for lightning protection, not a final recommendation.

What Lightning Is Lightning is the discharge of an electrical charge (that is, a potential difference) that builds up between some region of space and some other region of space. Air acts as an insulator, but breaks down (that is, arcs over) at some high voltage. The arc-over is a huge current pulse with a high rise time and short duration.

Spectrum and Waveshape Any short duration pulse consists of an infinite number of harmonics, the relative strength of which is determined by the rise time of the pulse and the impedance of the current path. *It is a major mistake to think of lightning as DC.* Yes, there's a DC component, but IEEE data shows that most of the energy in a lightning strike is in the MF spectrum (300 kHz-3 MHz). So when designing a ground system for lightning protection, we need to think AM Broadcast – according to IEEE data, on average, the energy in lightning has a VERY broad peak around 1 MHz (so broad that there's lots of energy at 2-4x that frequency and at 0.2x that frequency).

Common Bonding The single most important element of a lightning protection system is the bonding together of the reference planes (that is, circuit common) for every element of the system. A *bond* can be defined as a low impedance connection that is mechanically and electrically robust. At frequencies above a few hundred Hz, the impedance of virtually any conductor is dominated by inductance, not resistance. Bonding conductors should be "beefy" so that they don't melt, and as short as possible (so that they have low inductance).

Earth As a Reference Plane The earth is an important reference plane. We can think of earth as a plane of infinite size, but whose conductivity varies widely, depending on the chemistry and geology of the soil (or rock) and its moisture content, from fairly good to very poor. Conductivity can vary significantly between points that are very close together for a variety of reasons, both natural (the presence of rocks, streams, earth stratification) and manmade (excavation, land filling, building structure, buried pipes).

Lightning Protection The most fundamental elements of lightning protection are:

- ♦ A low impedance path for lightning to our reference plane (earth) that does not include our house or ham station
- ♦ Common bonding of our equipment so that, in the event of a lightning strike, the potential difference between equipment is minimized
- ♦ Protection devices on power, signal, and control wiring that is connected to our equipment

Earth Electrodes An earth electrode is an electrical connection to the soil, whether intentional or unintentional. A ground rod is an example of an intentional connection – what the NEC calls a "made" electrode. Any building or installation is likely to have many unintentional connections to earth – building steel, conductive cold water pipe, conductive gas pipe. *We can reduce the impedance to earth of an electrode by increasing the surface area in contact with the soil, but at lightning frequencies (radio), the major component of the impedance our ground system is the wire between the electrode and our equipment!*

UFER Electrodes Concrete can be a good electrical conductor or good insulator, depending on its formulation. Most concrete used in construction is a fairly good conductor. A Ufer (named for its inventor) is an electrical conductor encased in conductive concrete to form a made electrode. Structural steel on a concrete foundation acts as a Ufer, including a ham radio tower sitting on concrete that is electrically conductive.

Ground Electrodes in Difficult Soil Ground electrodes don't necessarily need to be vertical rods – if rocky soil makes vertical rods difficult, consider multiple shorter rods, or burying wires or conductive plates horizontally. The main reason for going deep below the surface is to get to in contact with moist (low resistivity) soil.

Bonding Earth Electrodes All earth electrodes that lightning might view as associated with our house or ham station should have an effective low impedance bond between them. The impedance to earth of a ground system will be the parallel combination of all earth electrodes (ground rods, building steel, tower footing, cold water, radials), plus the inductance of the wire connecting them. The capacitance between a big radial field and the earth can be a significant component of lowering that impedance in the 300 kHz – 3 MHz region where the energy of lightning is concentrated.

Star Bonding is designed to provide a low impedance path for lightning current to earth that does not include the building, the electrical system, or equipment within the building. It also provides a single path to earth for lightning current induced in building wiring, and minimizes the potential difference between equipment within the building in the case of a strike. In a star-bonded system:

- ♦ All the earth electrodes are bonded together
- ♦ All equipment and systems within a building are bonded together
- ♦ A single connection is made between the earth electrode system and the building systems (the center of the star)
- ♦ All external wiring is bonded to the center of the star – the power system neutral, shunt mode lightning protection devices, cable TV entry, the shields of antenna wiring, the base of a tower, etc.

Power System Bonding In North America, building codes generally require that an electrical installation conform to the National Electrical Code (NEC). A few cities (including Chicago, Los Angeles) have their own codes that are generally similar to NEC. These codes apply to premises systems – that is, buildings and facilities connected to mains power. They do not apply to systems that are strictly portable – for example, a motor generator in a vehicle, and they do not apply to power distribution systems outside buildings (that is, the power company's wiring). They do apply to a portable generator or solar system that is connected to premises wiring. Some industrial systems, such as those running heavy equipment are exempt from some of these requirements. See <http://audiosystemsgroup.com/SurgeXPowerGround.pdf> In general, North American building codes require:

- ♦ that all earth electrodes shall be bonded together
- ♦ that a bond shall be made from the earth electrode system **to a single point on the power system**. In a residential system, the point of connection must be to the neutral bus at the service entrance
- ♦ that one conductor of the power system (the *neutral*) be bonded to earth. NEC refers to the *neutral* as "*the grounded conductor*"
- ♦ that a third wire, called the *equipment ground*, or "green wire" (*protective earth* or *PE* in the UK) is carried to every mains power outlet, and via the power cord to exposed metal in all connected equipment

The sole function of the *equipment ground* is to blow a fuse or circuit breaker in the case of a fault (failure of equipment or wiring), thus protecting personnel from electrical shock and preventing fires. ***An equipment ground should never intentionally carry current (that is, serve as a return for load current). That is the function of the neutral.***

The bonding requirements of these standard building codes are based on solid engineering. They have been formulated and refined over the years by some of the best engineering minds on the planet, including many who are very aware of the RF implications of the requirements. ***There is no conflict between these grounding and bonding requirements and excellent performance of radio transmitting or receiving systems. Those who advocate separate, unconnected grounds for power and radio systems are simply wrong.***

SURGE SUPPRESSION

Surge Suppression devices are designed to prevent damage to equipment caused by lightning flowing into equipment. There two fundamental types – *shunt mode*, and *series mode*.

Shunt mode suppressors conduct the lightning current, hopefully diverting it away from the protected equipment (and often onto the *equipment ground* conductor). Gas discharge tubes and metal oxide varistors (MOV's) are the most commonly used shunt mode suppression devices. At low voltages, they look like an open circuit, but conduct when the voltage exceeds a certain threshold.

Series mode suppressors block the lightning current by adding a high reactive impedance (an inductor) in series with the lightning current. The energy in the lightning strike is stored in an inductor, then discharged slowly (and thus harmlessly) back into the power line. <http://www.surgex.com>

Disadvantages of Shunt Mode Suppressors There are three very strong negatives.

- ♦ When a shunt mode suppressor conducts a lightning strike to the equipment ground, the IR drop in the "green wire" raises the potential between the equipment ground at the "protected" outlet and other "grounds." Consider two pieces of gear plugged into different outlets, with signal wiring between them. One of them has a shunt mode suppressor, the other does not. Or perhaps they both have suppressors, but they see different lightning currents and have different lengths of green wire to "earth." In either situation, the difference in potential between the two equipment grounds can be thousands of volts for the instant of the strike, and one or both of those pieces of equipment is likely to experience a destructive failure.
- ♦ Shunt mode suppressors degrade and/or eventually fail, as they absorb some finite amount of energy. They may fail shorted or open. It is not practical to test for a degraded or "failed open" condition. As a result, it easy for a shunt mode device to have failed and offer little or no protection, but you don't know it!
- ♦ Shunt mode suppressors will conduct non-destructive noise spikes to the equipment ground, and the resulting noise current can radiate and be picked up on antenna systems.

Advantages of Shunt Mode Suppressors Shunt suppressors are much cheaper than series mode suppressors. They are the only practical method for protecting signal circuits and for protecting an entire building (that is, a "whole house" suppressor" at the service entrance).

Advantages of Series Mode Suppressors Series mode suppressors reliably protect equipment on branch circuits without causing destructive failures on equipment on other circuits.

Disadvantages of Series Mode Suppressors They are larger and more expensive than shunt mode suppressors, and it is not practical to build series mode suppressors with capacities larger than about 30A.

Recommended Surge Suppression Strategy

Install a "whole house" suppressor at the service entrance as your first line of defense against lightning coming in on the power line, and other power line faults.

Use series mode suppressors on branch circuits (that is, between the breaker panel and equipment) to control lightning induced on branch circuit wiring. ***Never use shunt mode suppressors (MOVs) on branch circuits.***

Use shunt mode devices only in parallel with the RF inputs of sensitive equipment (antenna inputs, inputs of telephone equipment, computer network equipment, etc.) ***When shunt mode devices are on balanced wiring (telco, ethernet, etc.), do not return them to the green wire; use the star ground as their return.***

Appendix 6 – Audio for Ham Radio

Input and Output Levels One of the most important parts of audio interconnection is getting the levels right. It's easy to do it right – as long as you know that you need to do it.

Output Levels The maximum output level of most computer sound cards is on the order of 1 volt RMS (corresponding roughly to digital clip). The output stage can usually produce enough current to drive most headphones to reasonable listening level. Most output stages will begin produce significant distortion about 6 dB below their maximum output level. For this reason, it is very important to stay below this level on digital modes like PSK31.

The maximum output level of most radios is also on the order of 1 volt RMS at clip level. Most will drive an 8 ohm loudspeaker.

Input Levels There are (at least) five common types of inputs, and each operates at a different level. Balanced mic level inputs typically operate between 1 mV and 100 mV rms, and may clip at 1 V rms. Unbalanced mic inputs typically work between about 10 mV and 250 mV, but may clip at levels as low as 250-500 mV rms. Balanced line inputs typically clip at about 10V rms.

Input and Output Impedances Contrary to popular belief, 600 ohm inputs and outputs haven't been used in pro audio in almost 40 years. Modern output stages have a low output impedance – typically 100 ohms or less for pro products, and 350 ohms or less for consumer products. Modern input stages have a high impedance – typically 1K for pro mic input, 10K for a pro line input, 50K for a consumer line input. In other words, modern equipment operates on the basis of voltage matching, not power matching. Line level output stages are designed to provide voltage, not current, and input stages are designed to not draw current.

The performance of a line level or mic level output degrades when it is connected to an input stage that "loads" it – that is, a low impedance input that draws current. Degradation comes in the form of reduced output level and increased distortion at higher output levels. Sadly, the designers of some ham gear haven't gotten the word, and still load their input stages with low value resistors. The Elecraft K2, for example, must be modified to work with a professional mic.

Loudspeaker Outputs There are two primary differences between a *line* output and a *loudspeaker* output of most ham rigs.

- ♦ A *loudspeaker* output is fed by a *power amplifier* that is designed to deliver current into an 8 ohm load. A line level output is fed by a simple stage that provides about the same voltage, but it is not designed to deliver current.
- ♦ A *line level* output is usually not affected by a front panel volume control.

Matching Levels An audio signal chain will have optimum sound quality and least noise pickup when its signal levels are matched. A simple way to describe correct level matching is to say that the gains are adjusted so that every stage in the signal chain is operating just below the level where distortion begins to rise drastically. For most analog stages, this is the "clip" level, where the tops of a sine wave would be clipped. For digital stages, it is 0 dB FS (0 dB re: full scale, where the A/D and D/A converters "run out of bits.") We don't want the signal to actually hit the clip level, but we want it to be about the same number of dB below clip (3-6 dB is a good range) at every point in the signal chain.

Matching levels does three things for us.

- ♦ It assures that distortion produced in the electronics will be minimal.
- ♦ It minimizes the contribution of each gain stage to the noise level.
- ♦ It minimizes the contribution of noise on interconnect wiring.

Speech Intelligibility The primary goal of most ham radio transmissions is communication. We are often working with less power, or an inferior antenna system, or in the presence of noise, over very long distances, or very difficult propagation. To get the most from our stations, we need to optimize their intelligibility. The major factors that contribute to intelligibility are:

- ♦ **Frequency content** Nearly all intelligibility in speech is contained between 400 Hz and 5

kHz, with the range between about 1 kHz and 3 kHz being most critical. Lower frequency sounds provide more pleasing sound ("body") and higher frequencies more "presence." To get the most "talk power," we want to concentrate our transmit power in the 500 – 3,000 Hz range, without wasting transmit power on the lower frequencies, and without allowing the higher frequencies to create (or receive) splatter from adjacent channels.

- ♦ **Equalization** is used to optimize the frequency content of the transmitted audio. We use low pass filters to reduce the strength of low frequency sound that eats transmitter power but doesn't contribute to intelligibility. We also use some response boost around 3 kHz to maximize clarity.
- ♦ **Signal to noise ratio** Speech intelligibility is degraded by noise. We can minimize the noise by minimizing the receive bandwidth (but not so much that we lose audio frequencies between 500 Hz and 3 kHz).
- ♦ **Dynamic processing** Human speech naturally has peaks and valleys of loudness. The loudest peaks can't be allowed to exceed our permitted transmitter power (or FM deviation), but we don't want the valleys to fall into the noise. That's where dynamic processing comes in – we use peak limiters and compressors just before the modulator in our radio to reduce the strength of peaks, then turn of the level on the entire voice signal so that the peaks just hit the maximum permitted output (or FM deviation). The difference between a peak limiter and a compressor is primarily their time constants – that is, compressors act relatively slowly to smooth out the difference between the loud and soft parts of speech, while peak limiters act very quickly to catch short term transients that would overmodulate the transmitter.

To sound good, dynamics processing must be done artfully – if the peaks are reduced too sharply, or excessively, the audio can be distorted and sound unnatural. In the transmit audio chain, the audio should first be equalized to achieve the desired frequency content (that is the balance between highs, mids, and lows), and then passed through the dynamics processing.

- ♦ **Time distortion and echoes** Anyone who works with sound systems in churches or auditoriums knows that sound that bounces around a room and arrives at our ears as reverberation or an echo degrades speech intelligibility. Echoes and time smear can also occur when a signal is propagated to us over multiple paths at the same time. It can be really tough to copy a signal that is reaching you by both a long path and a short path – one will be offset in time from the other, and you'll hear an echo.

The combination of good dynamics processing and careful shaping of the frequency response can make a 10-15 dB difference in "talk power." 10 dB is equivalent to multiplying your transmitter power by a factor of 10x; 15 dB is equivalent to 32x! Response shaping typically contributes 3-6 dB of that improvement, dynamics processing is good for 6-10 dB.

Microphones come in four basic types. Dynamic microphones have a diaphragm attached to a voice coil that moves within the field of a permanent magnet. Condenser (and electret condenser) microphones have a conductive diaphragm forms one plate of a capacitor. Most mics commonly used with telephones,, consumer equipment, and ham gear are electrets. Before electrets, carbon mics were widely used in telephones, and crystal mics were used with low cost consumer equipment.

Directional Patterns An *omnidirectional* mic picks up sound equally in all directions. A directional mic favors (usually) one direction (*cardioid*) or two directions (*bi-directional*, also called "*figure-of-8*"). Most performance mics are cardioids. Cardioids work by canceling the sound from a front and rear opening for sounds coming from directions other than the front. *Hypercardioid* and *super-cardioid* mics have a slightly narrower pattern than a cardioid, thanks to combining front and rear entry ports at a different ratio.

Noise-cancelling mics are designed to be used very close to the mouth and reject background noise. They use two capsules that are combined out of polarity to cancel sound more than an inch or two from the mic. Noise canceling mics are very subject to sibilance and breath noise, so they

don't sound very good, and should generally be used only when the background noise is so loud that communications would be difficult without them (aircraft cockpits, etc.). They are a poor choice for most ham radio applications.

Electret Mics Many modern microphones, and virtually all miniature microphones, have electret condenser capsules. They come in two basic forms. What these forms have in common is a VERY high-Z electret capsule (tens of megohms) with a FET follower to get it down to about 10K. The most common form of professional electret mics adds a gain stage with a balanced output to drive a professional sound mixer.

Phantom Power Professional condenser mics get their power from the balanced line in what the old telco guys would call simplex – that is, V+ equally on the signal pair, V- on the shield. This is called phantom power. Several common voltages are in use, with 48 volts through a matched pair 6.8K ohms to both sides of line being the most common. The mic has an on-board voltage regulator, and most mics actually work between 9 and 20 volts. There is also a nearly obsolete standard that put power in series, called T-power. It was popular with film folks for a while.

The second form of electret mic is designed to be used with unbalanced inputs, like those that are part of wireless mic transmitters. The capsule with the FET follower has unbalanced wiring to pig-tail leads, which are then soldered to the appropriate connector. Electret mics of this form can drive a ham rig directly, but need a small dc voltage from the transmitter to bias the FET (with a suitable series resistor). The mic connectors on most ham transceivers has DC available, but you'll need to add the resistor. Shure, Audio-Technica, AKG, and Sony all make miniature electret mics like this for use with wireless mics that will work well with ham transmitters; only Shure and Crown have "headworn" versions. Be sure to buy an omni-directional version though – the directional mics all have proximity effect, so they don't work well at all for communications use.

Proximity Effect Virtually all popular "vocal" microphones are directional mics, and nearly all of them exhibit proximity effect – the "boosting" of low frequencies for a sound source very close to the mic. The exception is the family of "variable-D" microphones made by Electro-Voice – the RE16, RE18, RE20, and RE27 (also the discontinued RE10, RE11, RE18, and 666). AKG and Shure used to make variable-D mics, and you may find them used. They are the AKG D202, D222, and D224, and the Shure SM53, SM54. If you're going to use a pro mic with your ham rig, it ought to be either one of these mics or one of the miniature omnidirectional electrets. I mostly use an RE16 for HF SSB. The advantage of the variable-D mic over the omni is that it rejects noise in your shack (like the fan in your power amp).

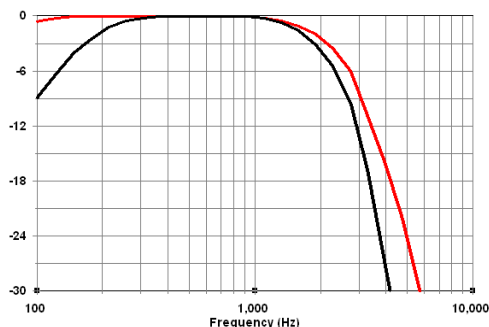

Fig A6-1a SSB TX and RX Response

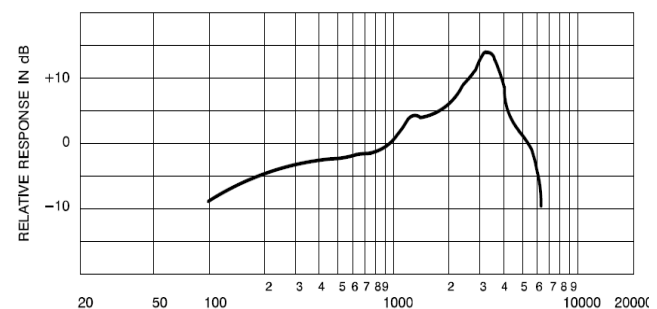

Fig A6-1b – Shure 450 Communications Mic

Frequency Response of SSB Fig A6-1a is the response of typical 2.7 kHz crystal filters used to generate and receive SSB. The red curve is the response of the TX filter alone; the black curve is the cascaded response of the TX filter and the filter in the receiver. In addition, an international standard calls for limiting bandwidth to 2kHz, and many SSB rigs have a built-in 2kHz rolloff. The frequency spectrum between about 1kHz and 3kHz is critical to good speech intelligibility, so the severe rolloff of Fig A6-1a tends to make speech somewhat muffled and indistinct. The rolloff can be compensated by boosting (pre-emphasizing) the response in the 2-4 kHz region. Virtually all popular "communications" microphones are built with this boost, so they sound fine. The Shure 450 (Fig A6-1b) and the various Heil mics are examples.

Using Professional Low Impedance Mics With Your Ham Gear Most pro mics, built with relatively flat (that is, accurate) response, sound muddy and dull when connected to many ham transceivers. Use a twisted pair cable that has a braid shield to connect the mic to your ham gear. This cable needs a 3-pin female XLR on the mic end and a suitable ham mic connector (usually 8-pins) on the other. The twisted pair goes to pins 2 and 3 of the XLR, and the shield goes to pin 1. The wire from pin 2 of the mic goes to the mic input of your radio. The wire from pin 3 to the "audio ground" of your radio. Wire the cable shield to the chassis of your radio (hopefully the mic connector is bonded to the chassis, but don't count on it – in many radios, it is not!)

If your ham gear is rolled off per the standard and doesn't have its own "equalization" to fix it (some radios do), you can add a simple RC equalization network to match the "flat" response of the pro mic to the rolled off response of the ham gear. The network consists of a capacitance in series with the wire from pin 2 to the input of the ham gear. Chose the capacitor so that its reactance is equal to the input resistance of the ham gear at 3 kHz, using the equation $C = 1 / 2\pi F X$. For example, if the input resistance of the mic input stage is 1 K, use C of about 0.027 uF (27 nF). If your audio is still a bit dull, make the capacitance value even smaller. If the audio is too thin, make the capacitance a bit larger. The Elecraft K3 has a built-in equalizer that can easily be set to provide the needed compensation.

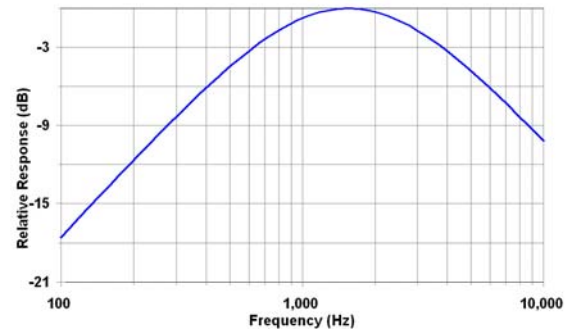

Fig A6-1c Response With Series Cap

Inexpensive Electret Mics work very well with almost any ham rig. Plantronics, first known for their excellent miniature "star-set" operator headsets, now makes a wide variety of miniature headworn earsets and headsets for use with computers and cell phones. Very good ones sell for about \$25; all it takes to use them with your ham rig is to connect them to your radio, adding a suitable bias resistor between the V+ terminal and the audio terminal (see below). You don't need a "gold plated" mic sold by the rock and roll ham – a \$25 Plantronics can give you very good and very competitive audio at a fraction of the cost!

There are three wires in the Plantronics cable, plus the shield. The shield goes to the chassis. Blue is common for the mic and earphone, and goes to common on the mic jack. One wire is the earphone, and goes to the audio out on the mic jack. The other wire is the mic, and goes to the mic input. To figure out which wire is which, stick the earphone in your ear and listen as you probe for it with an ohmmeter. When you hear the click, you've got the earphone. On the headsets I have, white is the mic, red is the earphone, blue is common.

You also need a bias resistor between the mic wire and +DC on the mic jack to provide bias for the mic capsule. As I recall, I used something like 5K-10K, but I don't remember and I don't remember it being critical. See your radio's manual for connector pinout – Kenwood, Icom, TenTec, and Yaesu all wire their mic jacks VERY differently.

Laptop Mic Inputs vary widely, and those who have studied them extensively say there are no real standards. Fig A6-2a is the most common configuration. Fig A6-2b is another. The tip of the 1/8-inch connector is the mic input, with the connector shell as the return. The ring of the connector is +5VDC through a 3.3K resistor (measured on my IBM Thinkpad). Connect a dynamic mic between tip and sleeve. This works perfectly on my IBM T22, but MY IBM T41 uses a somewhat different input circuit that is noisy and unstable with this simple connection. I tamed it by adding 0.22 μ F between tip and ring. An electret ham mic may work with audio to tip and power to ring. Or you may need to add resistance in series with the ring. Or you may need the capacitor. Or both. Plantronics headsets work great with my IBM T-series laptops with the mic going between tip and sleeve of the TRS mic jack and a 36K resistor between tip and ring.

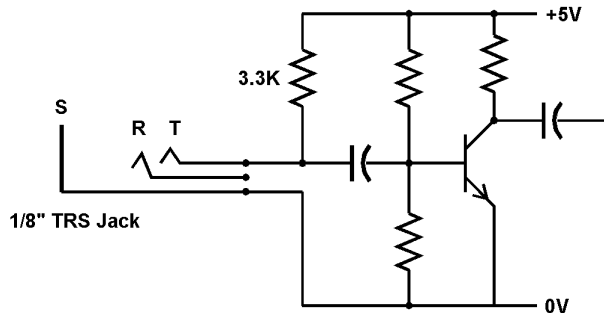

Fig A6-2a Conceptual Laptop Mic Input #1

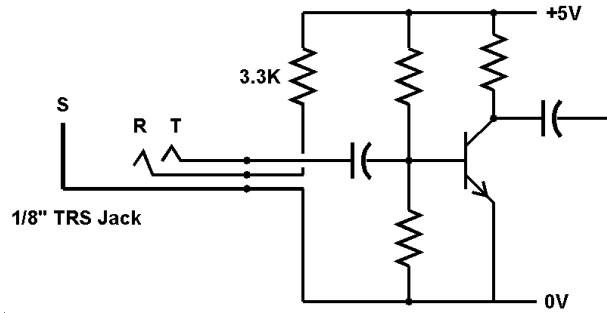

Fig A6-2b Conceptual Laptop Mic Input #2

The Yamaha CM500 Headset is just about ideal for ham radio. The headphones are quite comfortable, even for long periods in a contest, they sound very good, and they have fairly good isolation from room sounds. The mic sounds great too (a lot better than the Heil mics I've heard), and it's response is nearly ideal for ham radio. Not only that, it's a bargain, at about \$45 from good discount vendors of semi-pro audio products. All it needs is bias for its electret capsule and a bit of low frequency rolloff to minimize breath pops. With my K3, I set the two lowest octave bands of the TX equalizer to full cut. For rigs that lack an equalizer, simply add a small capacitor in series with the mic input to the rig.



Fig A6-3 Yamaha CM500 Headset

The CM500 plugs straight into the rear panel mic and headphone jacks on the K3, and to the mic and headphone jacks of most computers. For other rigs you will need a simple adapter to mate the CM500's 1/8-inch 3-circuit plug with the rig's mic connector. Wire a 3-circuit 1/8-inch jack with the tip going to the rig's mic input, and connect a 5.6KΩ resistor between the tip and +8VDC on the rig mic connector. Neither the resistor value nor the voltage is critical – anything from about 5V to 12V and from about 3.9KΩ to about 6.8KΩ will work. For lower voltages, use a lower resistor value, for higher voltages a higher resistor value. If you're going to add a small capacitor to roll off the low end, place it in series between the two connectors, but with the 5.6K resistor connecting to the microphone side of the capacitor. See Chapter 8 for part numbers and internet sources for good quality 1/8-inch plugs and jacks.

Impedance of Loudspeakers and Headphones The impedance of a transducer describes the relationship between voltage and current, just as with any other passive element. These transducers move air, so they require some power to operate. Headphones move much less air than loudspeakers, so needs much less power. A transducer can take that power with a little voltage and a lot of current (low impedance) a lot of voltage and a little current (high impedance), or anywhere in between.

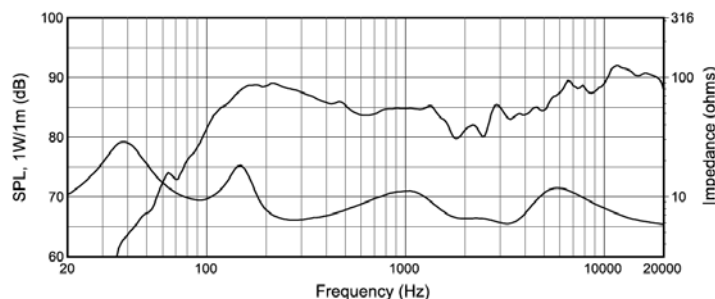

Fig A6-4 – A typical small loudspeaker. The lower curve is impedance, upper curve is voltage sensitivity

The impedance of a dynamic transducer (loudspeaker, headphones, dynamic mics) is not constant – it varies widely with frequency. The variations are the result of mechanical resonances in the transducer and its enclosure. Fig A6-4 is the impedance of a typical loudspeaker. Headphone impedance varies in a similar way, but manufacturers rarely publish graphs of their impedance. By international standard, the impedance of a transducer is defined as the minimum impedance within the audio spectrum. For most full-range transducers, the minimum impedance point is between 200 Hz and 1 kHz. Most loudspeakers have an impedance between 4 and 16 ohms; headphones are typically 50 – 1,000 ohms.

Loudspeakers and Dynamic Mics are exactly the same in principal – a diaphragm mechanically mounted to a coil, moving in the gap of a magnet. The loudspeaker is optimized to produce sound, the mic to detect it. Good audio technicians know that loudspeakers and dynamic mic both work in reverse. That is, if you momentarily connect ohmmeter probes or a battery to a dynamic mic, you'll hear the diaphragm click, and if you connect a loudspeaker to a mic preamp, you'll hear sound from the room that the loudspeaker is in. Many school intercoms work this way – the speaker at the front of the classroom can be rigged to let the principal listen in!

Loudspeaker and Headphone Sensitivity This is a measure of how much power is needed to achieve a given sound pressure level. Because the impedance of real loudspeakers and headphones varies so widely with frequency, sensitivity (and the frequency response) is generally defined at a constant voltage that produces 1 watt at the low impedance point. The zero dB reference for sound pressure level is a very soft sound. Small loudspeakers suitable for use in a ham shack typically have sensitivity of 75 – 85 dB at one meter for one watt, but a more sensitive one (85-95 dB) could help cut through road noise when operating mobile, especially if the speaker output amplifier is on the anemic side.

Power Amplifier Output Impedance Loudspeakers are driven by power amplifiers that have very low output impedances, typically a few tenths (or even hundredths) of an ohm. The combination of the power amplifier's output impedance and the loudspeaker form a simple voltage divider. The output impedance must be small for two reasons: 1) so that power is not wasted; and 2) so that the variable impedance of the loudspeaker does not modify the frequency response of the system.

Headphone Outputs are typically driven by small power amplifiers, or through series resistors from the same power amplifier that drives the loudspeaker. Why are the resistors needed? Most headphones use three circuit (stereo) plugs, but some use 2-circuit plugs. When we plug stereo headphones into the radio, we want to hear audio in both ears, so both tip and ring must be driven. The resistors are there to prevent the power amplifier from seeing a short circuit when a 2-circuit (mono) phone plug is plugged into the headphone jack.

Effect of the Resistors The resistors, in effect, raise the output impedance at the headphone jack. The resistors will do two things to the sound quality. 1) They will reduce the overall loudness; and 2) they will modify the frequency response. Both of these effects will be small if the impedance of the headphones is high (3x the resistor value), and greater if the impedance of the headphones is low (equal to or smaller than the resistor value).

Headphone Acoustic Types *Closed Ear* headphones block room sounds, while *Open Air* headphones let sound from the room come through. *In the Ear* headphones are miniature transducers that fit in the ear.

In the Ear Headphones Professional quality *In the Ear* headphones can provide excellent isolation from room noise, thanks to the acoustic seal formed between the earbud and the ear canal. Better models come with several pairs of "ear buds" to fit different size ears. The ultimate in isolation and comfort is achieved by having custom *earmolds* fitted by an audiologist. I'm quite satisfied with the stock earmolds that come standard with the Shure and Etymotic Research models listed below.

Noise Cancelling Headphones work by picking up room sound from a microphones on the outside of each earphone, amplifying them, adding it to the electrical signal to each ear so that it is heard out of polarity with the acoustic leakage around the headphone's seal. To cancel, the two signals must be precisely equal in amplitude, precisely in phase, but also out of polarity at the ears. The amplitude and phase match is much easier to achieve at lower frequencies, where the physical

spacing between the noise sense mic and the earphone is the smallest fraction of a wavelength, and difficult where the spacing becomes a significant fraction of a wavelength, and thus contributes phase shift. To some extent, this can be compensated by a digital delay network within the electronics, but that adds both cost and battery drain.

RECOMMENDED HEADPHONES FOR HAM RADIO APPLICATIONS

Nearly any good quality hi-fi or professional headset will have very good sound quality for ham radio applications. In order of importance, my criteria are:

- ♦ Physical comfort
- ♦ Noise isolation
- ♦ Compact size to fit in a briefcase
- ♦ Impedance around 100 ohms is a good compromise between voltage sensitivity and less interaction with the series protection resistors. Lower impedance may provide more sound level with some products that use lower value series resistors.

AKG, *Audio Technica*, and *Sony* all make a wide range of very good *Open Air* headphones. The Sony MDR7506's are quite comfortable.

Shure and *Etymotic Research*, both based near Chicago, make excellent *In the Ear* headphones. I like the *Shure E3*, *E4*, and *E5* models, and the *Etymotic Research ER4*. I haven't used the lower cost ER6's, but would expect them to be very nice. I find these in-ear headphones to be quite comfortable for long-haul contest operation. The Shure E1's are too big and clunky to be comfortable.

I consider *In the Ear* headphones a far better solution for ham radio than noise canceling headphones for three reasons. First, the recommended *In the Ear* headphones provide much better isolation from room sound than noise canceling models. Second, I've seen several complaints of RFI in some noise canceling headphones. Third, *In the Ear* headphones are passive, so they are simpler and less likely to fail.

The earphones that are part of the Yamaha CM500 headset (see Fig A6-3) are an excellent choice for ham radio.

Appendix 7 – Measuring Impedance With Antenna Analyzers

Antenna analyzers are a very useful tool, but to use them effectively (and get accurate results), we must understand their limitations.

- 1) Most antenna analyzers operate either as SWR analyzers or reflection analyzers, and measure relative to some specified characteristic impedance (usually 50 ohms, but some analyzers can be set for 75 ohms). They are most accurate when the SWR is low (that is, when the unknown impedance is near that characteristic impedance), and become increasingly inaccurate when the SWR is high.
- 2) There is a definite upper limit on the magnitude of the impedance that can be measured. For the MFJ259B, it is 500 ohms. For the AEA CIA-HF, it is 1,000 ohms. Some newer analyzers can measure up to 2,000 ohms.
- 3) In general, antenna analyzers cannot resolve phase angles within 5 degrees of 0 degrees and 90 degrees.
- 4) In general, antenna analyzers do not know the sign of the phase angle (that is, they don't know whether the unknown impedance is capacitive or inductive).
- 5) In general, antenna analyzers have a fairly low input impedance. Typical values are 10K ohms in parallel with 12 pF. This further reduces the maximum impedance that can be measured (unless it is known and subtracted from the measured result).

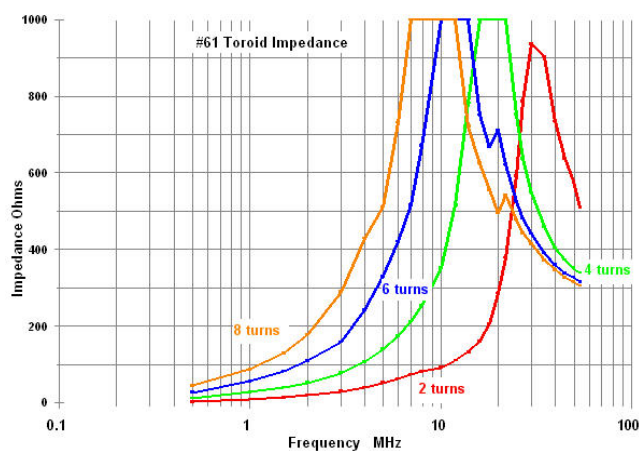

Using an AEA CIA-HF Antenna Analyzer

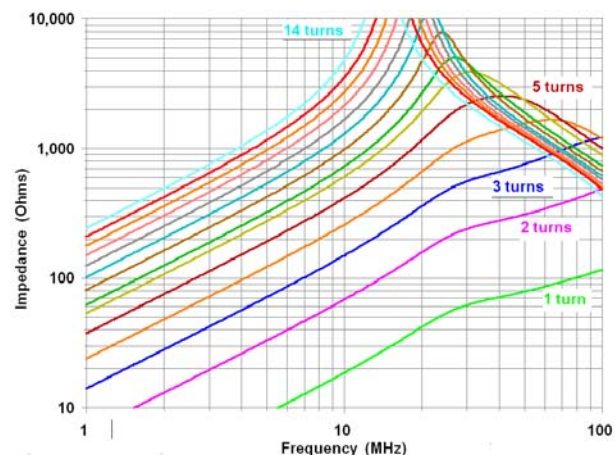

Using HP 8753C with HP85046A S-Parameter Test Set and HP85052D Calibration Kit

To appreciate the limitation of the AEA's 12 pF input capacitance, let's begin by computing its reactance. At 25 MHz, 12 pF is only 530 ohms; at 10 MHz, it's 1,327 ohms; and at 2 MHz it is 6,600 ohms. It's clear that if we're trying to measure an impedance of 1,000 ohms or more above about 4 MHz, the 12 pF input capacitance will cause major errors. To appreciate how large these errors can be, consider the two data sets above for coils wound around a Fair-Rite #61 2.4" i.d. toroid. For example, compare the data for the 6 turn coil. The AEA data shows resonance at about 12 MHz and suggests an impedance at resonance of about 1.5K. The more accurate HP system shows the resonance at 30 MHz, with $Z = 4,000$ ohms; at 12 MHz, the impedance is actually about 600 ohms and is strongly inductive.

Thus, the stray capacitance of the analyzer (about 12 pF) is resonating with the coil to move the resonance down by a factor of nearly 3:1. The actual impedance of the choke is thus much higher than the AEA shows at 30 MHz, and much lower at 12 MHz. In other words, the antenna analyzer has completely mis-characterized the coil.

So the obvious question is, how (and under what conditions) can we use an antenna analyzer to characterize ferrite parts? As a starting point, I'll offer the following guidelines.

- ♦ **Stray Capacitance** To minimize the error caused by stray capacitance, wind just enough turns around the ferrite part in question to achieve a resonant peak whose impedance is one third or less of the reactance that the input capacitance of the analyzer has at the frequency of the resonance. At frequencies well below the measured resonance, the impedance of a single turn through the ferrite part is approximately equal to the measured impedance divided by the square of the number of turns. Now, use the guidelines of chapter xxx to estimate the resonant frequency of the ferrite part for a single turn.

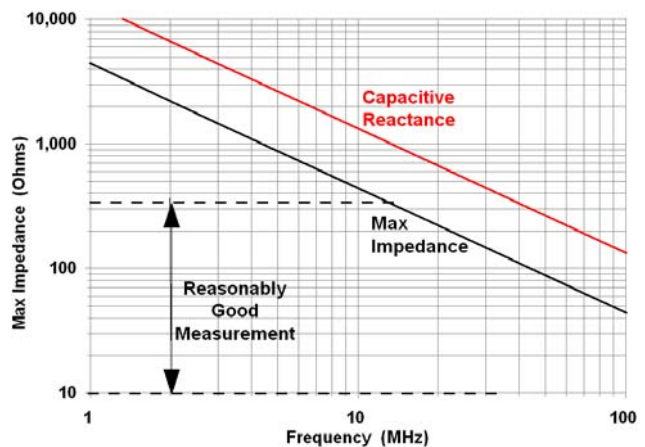

Fig A7-2 Useful Measurement Range of Antenna Analyzer

- ♦ The fact that the analyzer loses accuracy for values of impedance widely displaced from the characteristic impedance for which it was designed, leads to another rule of thumb for 50 ohm analyzers: use just enough turns around the ferrite part to keep the data within the range of 10 – 250 ohms.

Figure A7-2 illustrates these guidelines graphically. The dashed lines show the guidelines based on Z between $1/5$ and $5x Z_0$ of 50 ohms. The solid black line shows the guideline for keeping the resonant peak less than one third the reactance of the stray capacitance.

Correcting For Input Impedance Better accuracy at high frequencies can be achieved by expressing the measured impedance as R_p and X_p , taking the reciprocal of R_p to yield input conductance, then subtracting the input conductance and capacitance from the measured data. To perform this computation, the sign of the reactance must also be known. The resulting measurement will still be subject to the errors associated with measuring impedance well away from 50 ohms.

A Better Way to Measure Chokes The test setup shown in Fig 40 (page 31) is a very good way to measure chokes. You need a decent RF signal generator and a way to measure RF voltage accurately over the frequency range of interest. If you are lucky enough to have access to a Vector Network Analyzer, you can get good data by connecting the choke between input and output measuring S_{21} . This is the VNA equivalent of the method described in Fig 40.

Antenna Analyzers, Vector Network Analyzers, Impedance Analyzers, and Chokes All of these analyzers are designed to measure impedances that are relatively close to the characteristic impedance of a 50 or 75 ohms (within a 10:1 or 1:10 ratio). The common mode chokes we're trying to measure typically have parallel equivalent resistance of 1,000 – 5,000 ohms and equivalent parallel capacitance of 1 – 7 pF. A choke optimized for use on 14 – 30 MHz may have parallel capacitance as low as 1-2 pF. To measure these chokes to 10% accuracy, an analyzer (or its test fixture) must have an input impedance of at least 10X the parallel equivalent resistance of the choke and 1/10 the parallel equivalent capacitance of the choke.

The AIM 4170 is a nice analyzer, and provide very good performance relative to its cost. It cannot, however, accurately measure the impedance of these chokes above about 5 MHz, simply because its input capacitance is too large relative to the capacitance of the chokes. I've worked very hard to get good data for these chokes using the TenTec VNA. The best I can do is to get good data up to about 7 MHz, and then only if I use it to measure S_{21} of the unknown as a series element. Above that frequency, the software is not capable of accurately "calibrating out" the test fixture to yield magnitude data that matches the HP test rig.

I suspect it may be possible to get good complex data for chokes with an HP VNA measuring S_{21} . Kevin, K6TD, and I have done some work with this, but haven't been able to get the data out of his analyzer in a form that allows us to adequately test its validity, and my primary collaborator has been too buried in work to get at it. We're still working on it as we have time.